

Contents

1. Description	3
1.1 General Description	3
1.2 Features	3
1.3 Application	3
1.4 Package Dimension	4
1.5 Product Parameters	5
1.6 Bin Range Of Forward Voltage and Luminous Flux	6
1.7 Typical Optical Characteristics Curves	7
2. Packaging	11
2.1 Packaging Specification	11
2.1.1 Carrier Tape Dimension	11
2.1.2 Reel Dimension	11
2.1.3 Label Form Specification	12
2.2 Moisture Resistant Packing	12
2.3 Cardboard Box	12
2.4 Reliability Test Items And Conditions	13
2.5 Criteria For Judging Damage	14
3. SMT Reflow Soldering Instructions SMT	15
3.1 SMT Reflow Soldering Instructions SMT	15
4. Handling Precautions	17
4.1 Handling Precautions	17



1.4 Package Dimension

Fig.1-1 Top View

Fig.1-2 Side View

Fig.1-3 Bottom View

Fig.1-4 Polarity

Fig.1-5 Soldering Patterns

Notes

All dimensions units are millimeters.

All dimensions tolerances are ± 0.2

1.5 Product Parameters

Table 1-1 Electrical / Optical Characteristics at Ts=25°C

Item	Symbol	Test Condition	Value			Unit
			Min.	Typ.	Max.	
Forward Voltage	V_F	$I_F=350mA$	1.8	---	2.4	V

Table 1-2 Absolute Maximum Ratings at Ts=25°C

REFOND

Notes

1. 1/10 Duty cycle, 0.1ms pulse width.
2. The above forward voltage measurement allowance tolerance is $\pm 0.1V$. $\pm 0.1V$.
3. The above color coordinates measurement allowance tolerance is ± 0.005 . \pm
4. The above luminous intensity measurement allowance tolerance $\pm 10\%$. $\pm 10\%$.
5. Care is to be taken that power dissipation does not exceed the absolute maximum rating of the product.
6. All measurements were made under the standardized environment of Refond.
7. When the LEDs are in operation the maximum current should be decided after measuring the package temperature, junction temperature should not exceed the maximum rate
8. ESD yield is over 90% at 8000V ESD (HBM). ESD protection during products handling is needed. 90%
000V

1.6 Bin Range Of Forward Voltage and Luminous Flux (IF=350mA)

BIN (IF=350mA)

Table 1-3

V _F V	B1	B2	C1	C2	D1	D2
	1.8-1.9	1.9-2.0	2.0-2.1	2.1-2.2	2.2-2.3	2.3-2.4
Im	NA	NB	OA	OB		
	37-40.9	40.9-45.3	45.3-50	50-55.3		
WD(nm)	D2	E1	E2	F1		
	617.5-620	620-622.5	622.5-625	625-627.5		

1.7 Typical Optical Characteristics Curves

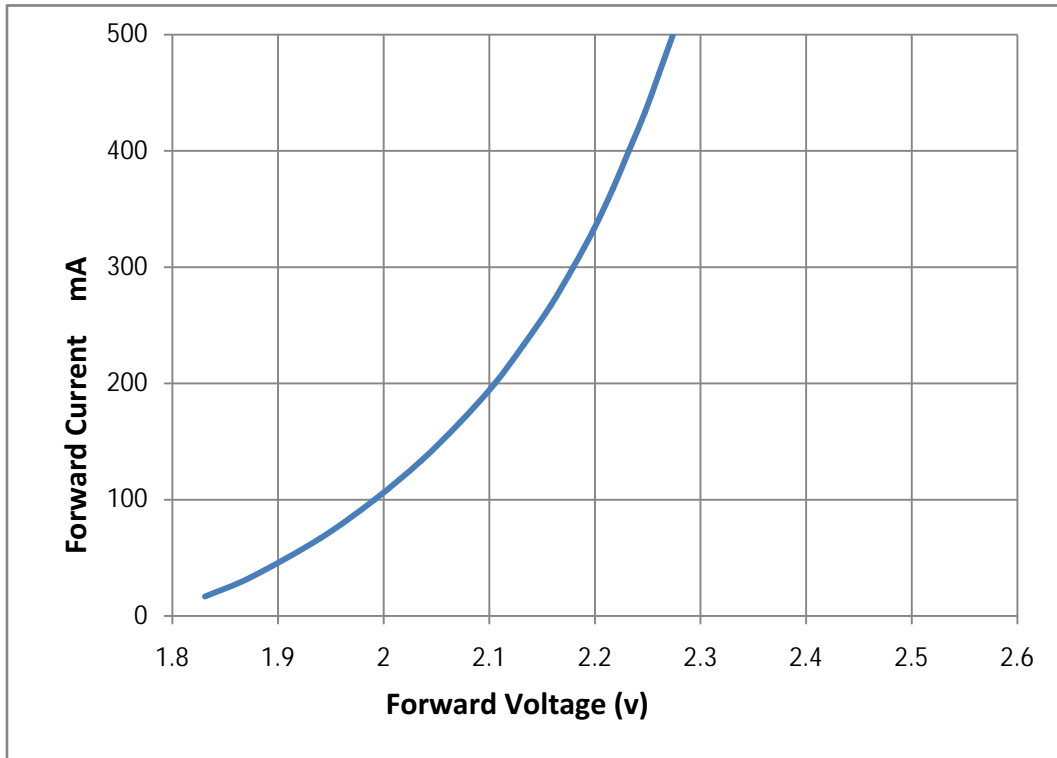

Fig. 1-7 Forward Voltage Vs Forward Current

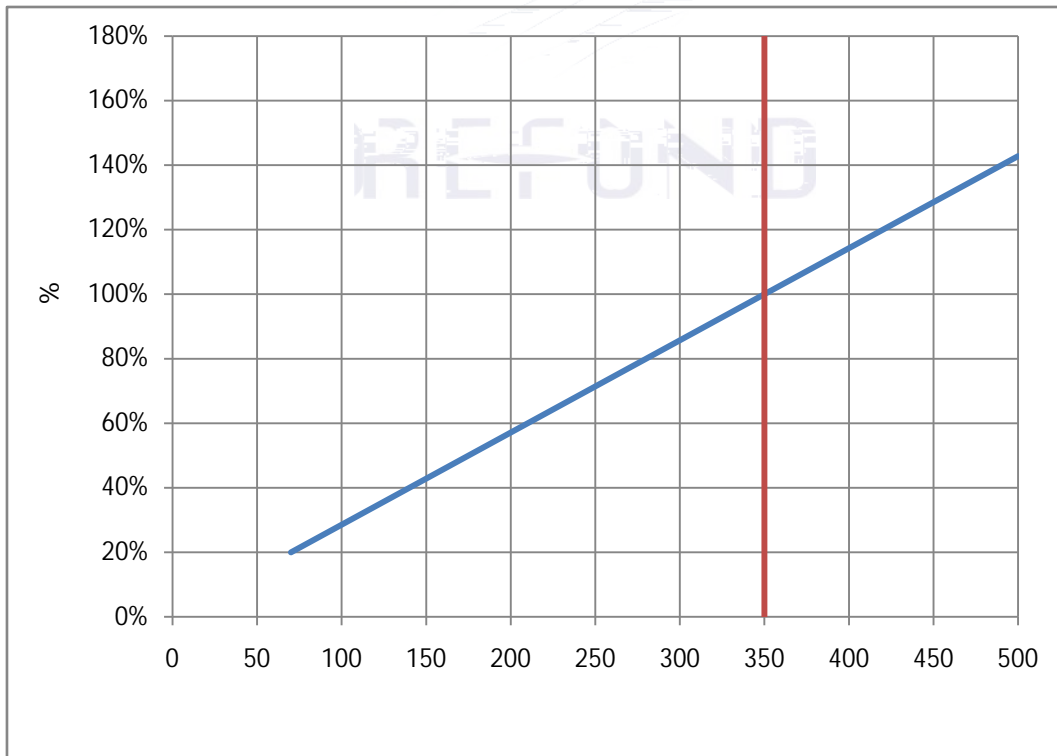

Fig. 1-8 Forward Current Vs Relative Intensity

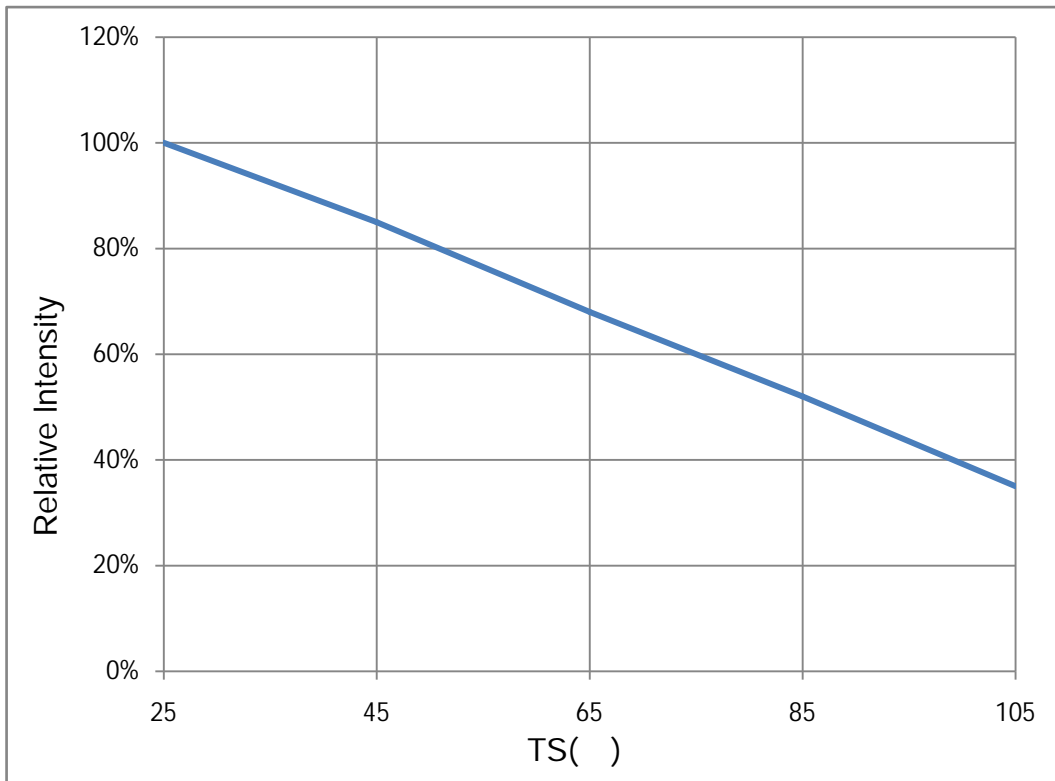

Fig. 1-9 Solder Temperature Vs Relative Intensity

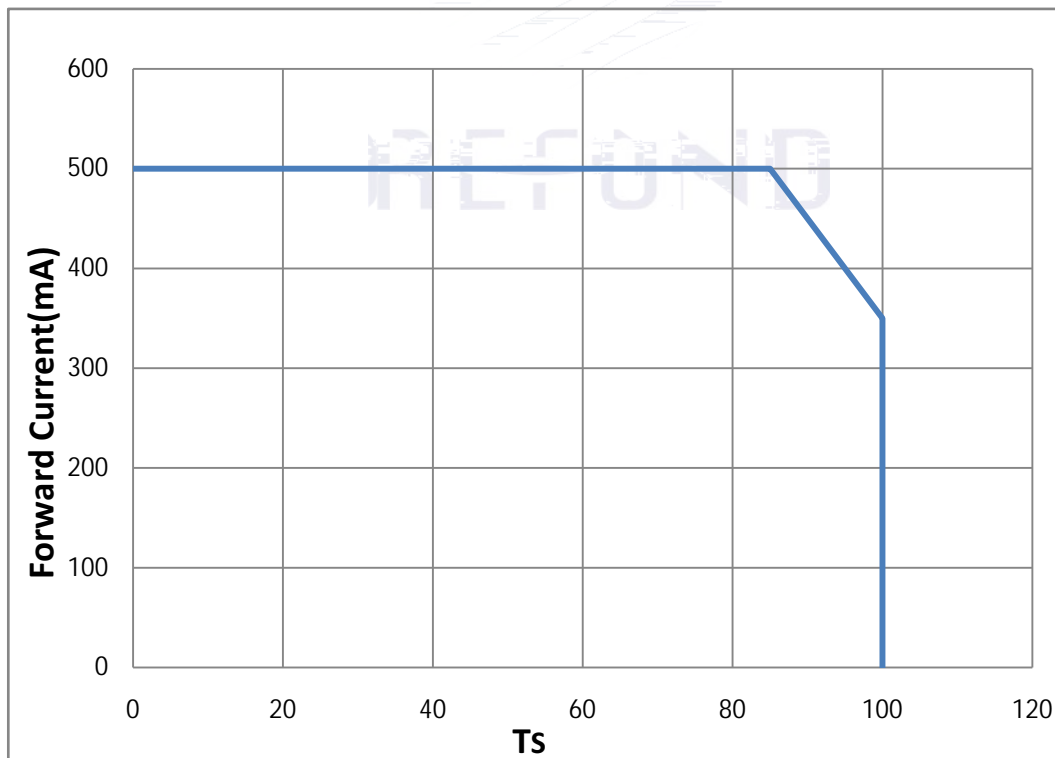

Fig. 1-10 Solder Temperature Vs Forward Current

Tj 125

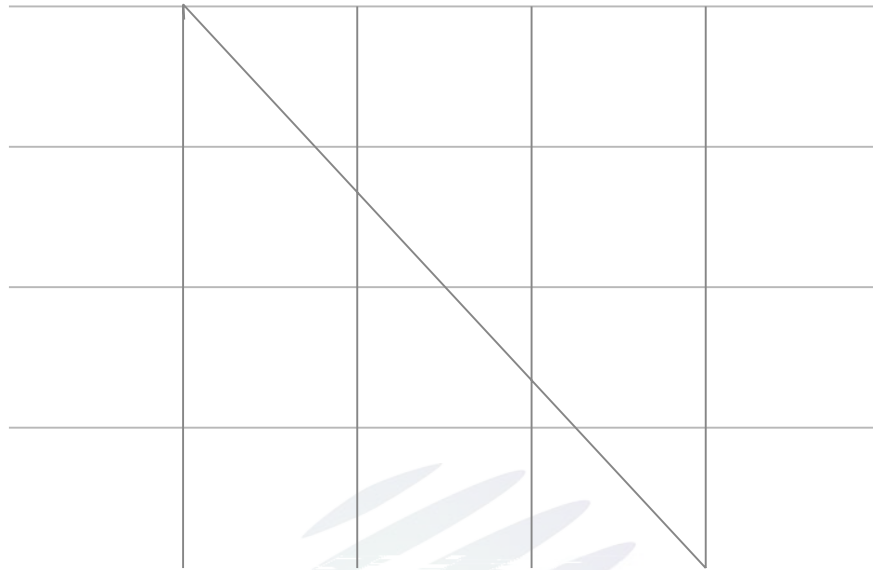

Fig. 1-11 Forward Voltage Vs Solder Temperature

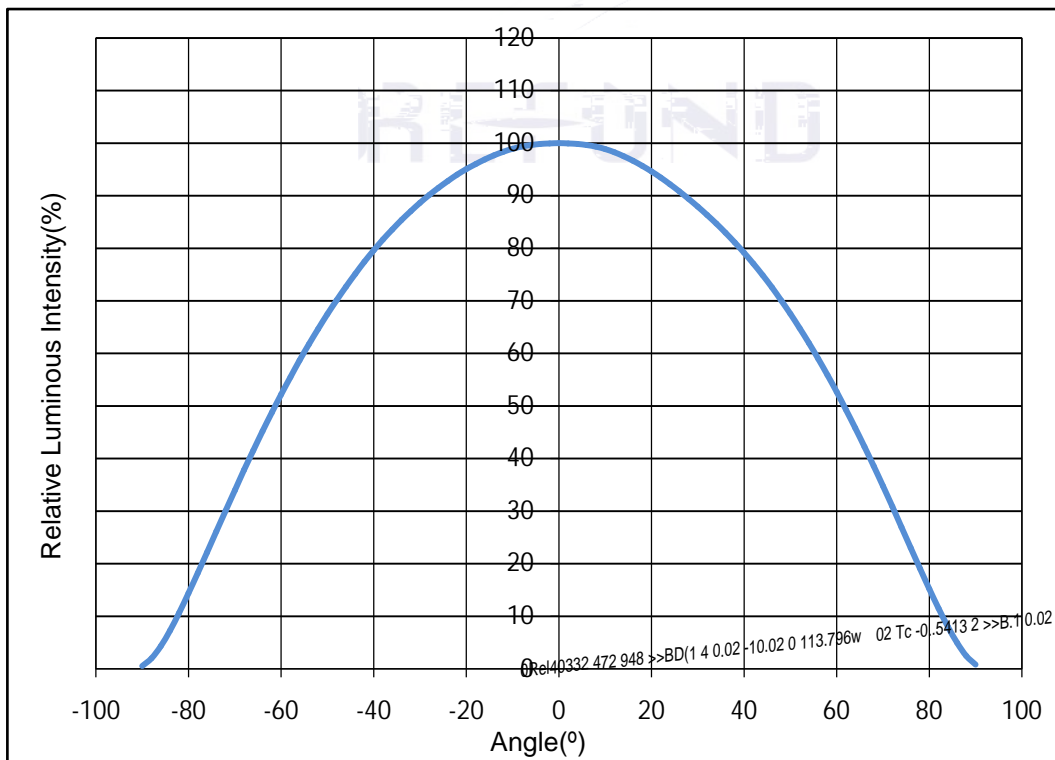

Fig. 1-12 Radiation diagram

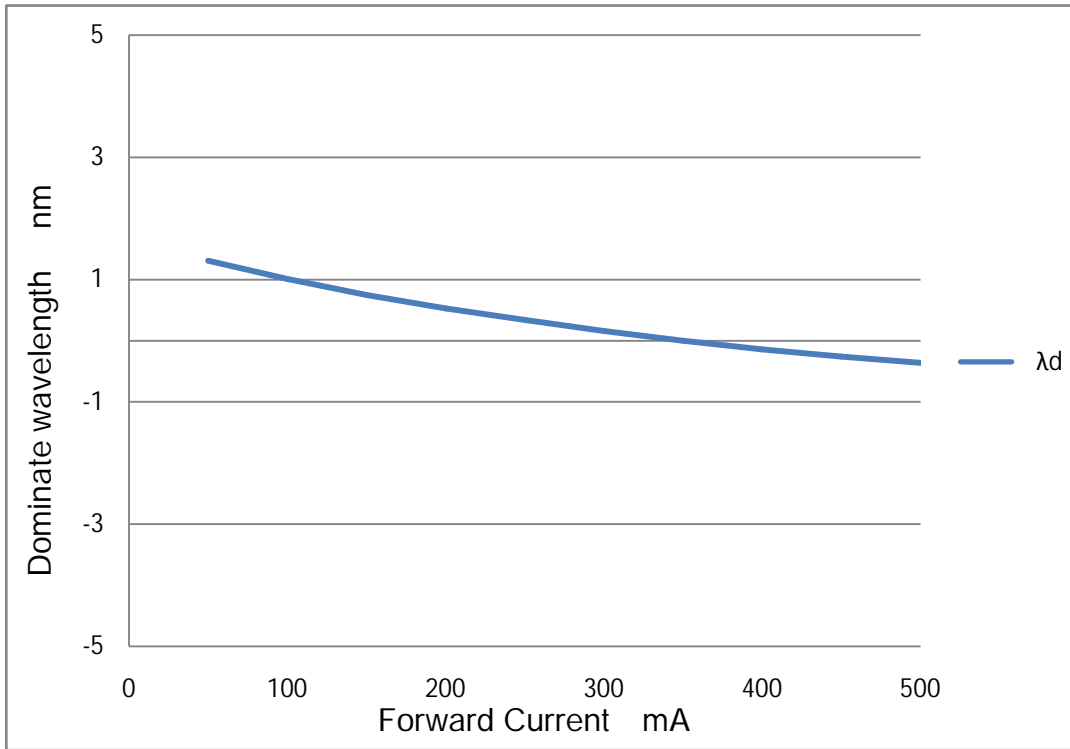

Fig. 1-12 Forward current vs. Dominant wavelength (Ts=25°C)

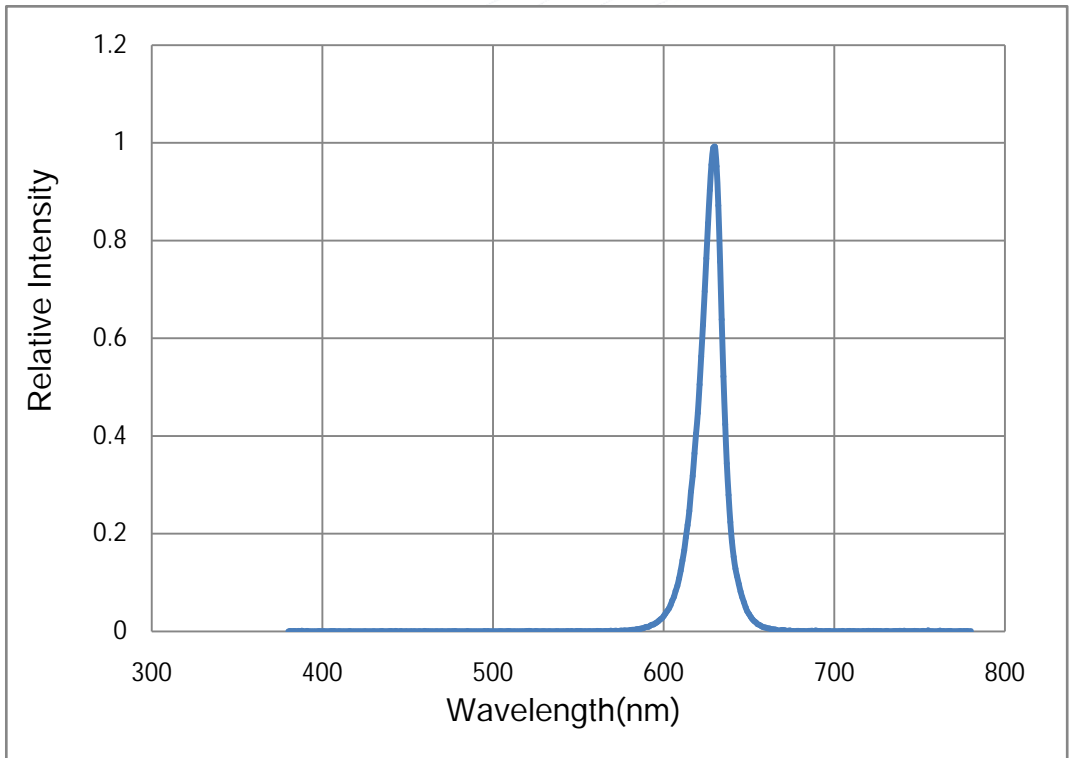

Fig. 1-14 Spectrum Distribution

2. Packaging

2.1 Packaging Specification

Package: 4000pcs/reel. 4000pcs

2.1.1 Carrier Tape Dimension

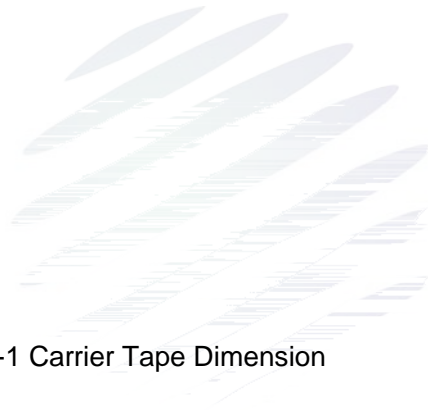

Fig.2-1 Carrier Tape Dimension

2.1.2 Reel Dimension

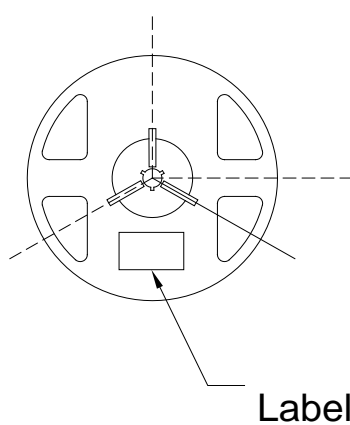

Fig.2-2 Reel Dimension

REFOND

Reel Dimension

A	12±0.1mm
B	180±1mm
C	60±1mm
D	13.0±0.5mm

Notes

The tolerances unless mentioned ±0.1mm. Unit : mm

±0.

2.1.3 Label Form Specification

Specification	
PART NO.	Part Number
SPEC NO.	Spec Number
LOT NO.	Lot Number
BIN CODE	Bin Code
	Luminous flux
XY	Chromaticity Bin
V _F	Forward Voltage
WLD	Wavelength
QTY	Packing Quantity
DATE	Made Date

Fig. 2-3 Label Form Specification

2.2 Moisture Resistant Packing

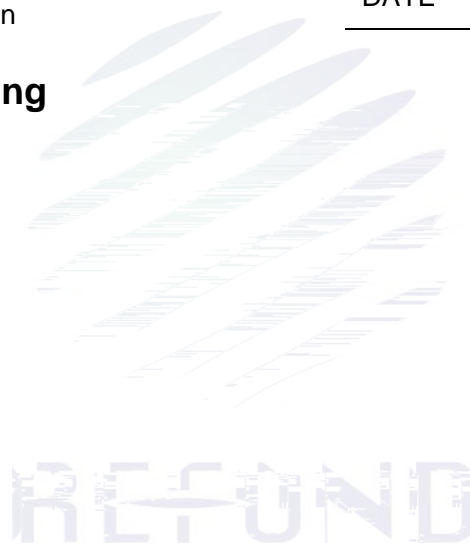

Fig.2-4 Moisture Resistant Packing

2.3 Cardboard Box

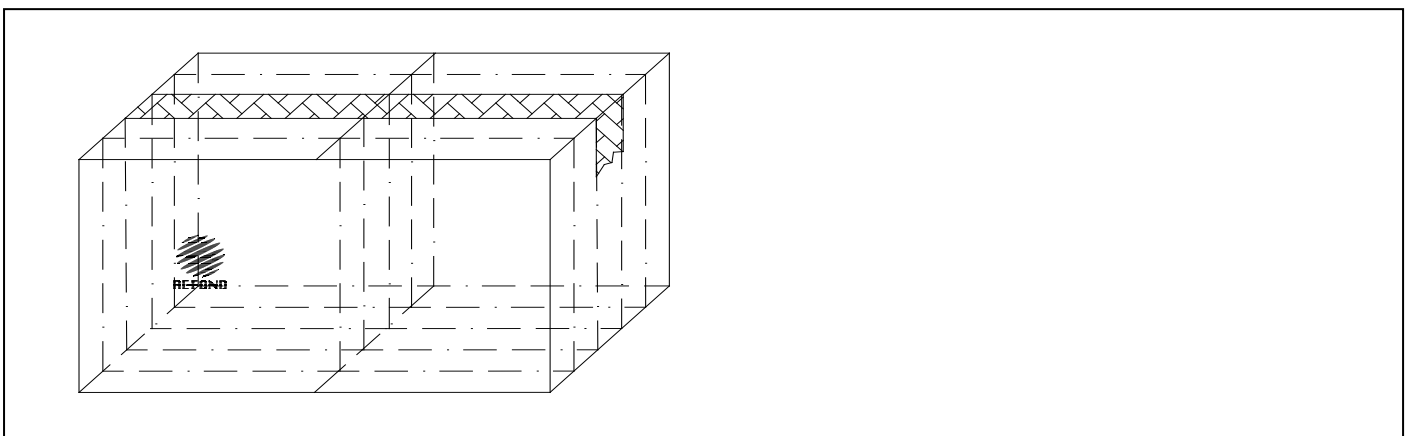

Fig.2-5 Cardboard Box

2.4 Reliability Test Items And Conditions

Table 2-3 Reliability Test Items And Conditions

Test Items	Ref.Standard	Test Condition	Time	Quantity	Ac/Re /
Reflow	JESD22-B106	Temp:260 max T=10 sec	2times	20pcs.	0/1
Thermal Shock	JEITAED-4701 300307	-40 15min 10s 125 15min	1000 cycle	20pcs.	0/1
High Temperature Storage	JEITAED-4701 200 201	Temp:125	1000hrs.	20pcs.	0/1
Low Temperature Storage	JEITA ED-4701 200 202	Temp:-40	1000hrs.	20pcs.	0/1
Life Test	JESD22-A108	Ta=25 If=350mA	1000hrs.	20pcs.	0/1
High Temperature High Humidity Life Test	JESD22-A101	85 / 85%RH If=350mA	1000hrs.	20pcs.	0/1
Temperature Humidity Storage	JEITA ED-4701 100 103	TA=85 RH=85%	1000hrs.	20pcs.	0/1

2.5 Criteria For Judging Damage

Table 2-4Criteria For Judging Damage

Test Items	Symbol	Test Condition	Criteria For Judgement	
			Min.	Max.
Forward Voltage	V_F	$I_F=350\text{mA}$	-	U.S.L*)x1.1
Reverse Current	I_R	$V_R = 5\text{V}$	-	U.S.L*)x2.0
Luminous Flux		$I_F=350\text{mA}$	L.S.L*)x0.7	-

Notes

- 1.U.S.L: Upper standard level L.S.L: Lower standard level
- 2.The above reliability tests is based on the verification of a single/strip LED of Refond's existing experimental platform,the reliability experiment was taken under good heat dissipation conditions. when customers applies the LED to the series and parallel circuit, should take consideration of all the factors such as the current, voltage distribution, heat dissipation and others.
- 3.The technical information shown in the data sheets is limited to the typical characteristics and circuit examples of the referenced products. It does not constitute the warranting of industrial property nor the granting of any license.

3. SMT Reflow Soldering Instructions SMT

3.1 SMT Reflow Soldering Instructions SMT

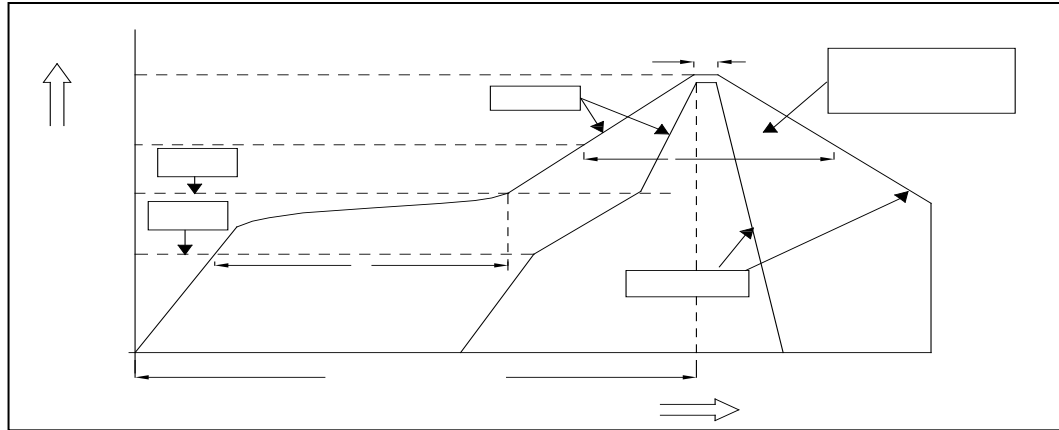

Fig.3-1 SMT Reflow Soldering Instructions SMT

Table 3-1 Reflow parameters

Average temperature rise speed	T_{smax} T_P	3 °C/ Max 3 °C/ s
Preheating: minimum temperature	(T_{smin})	150 °C
Preheating: Max temperature	(T_{smax})	200 °C
Preheating: Time	T_{smin} T_{smax}	60 - 120 60s-120s
Time limited to maintain high temperature: the temperature	(T_L)	217 °C
Time limited to maintain high temperature: The Time	(t_L)	60 Max 60s
Peak /Classification of temperature:	/ (T_P)	260 °C
Time limit classification of peak temperature time	t_p	10 Max 10s
5 °C with the actual peak temperature (T_P)	(T_P) 5 °C Hold time within	30 Max 30s
Cooling speed		6 °C/ Max 6 °C/ s
25 °C	Needed time from 25 °C to T_p	8 Max 8 minutes

Notes

(1) Reflow soldering should not be done more than twice. If more than 24 hours between the two solderings, LED will be damaged.

(2) When soldering, do not put stress on the LEDs during heating.

3.1.1 Soldering Iron

(1) When do soldering by hand, keep the temperature of iron below less 300 less than 3 seconds

(2) Soldering by hand should be done only one time.

3.1.2 Repairing

Repairing should not be done after the LEDs have been soldered. When repairing is unavoidable, a double-head soldering iron should be used (as below figure). It should be confirmed in advance whether the characteristics of LEDs will or not be damaged by repairing.

LED

3.1.3 Cautions

The encapsulated material of the LEDs is silicone. Therefore the LEDs have a soft surface on the top of package. The pressure to the top surface will be impacted on the reliability of the LEDs. Precautions should be taken to avoid the strong pressure on the encapsulated part. So when use the picking up nozzle, the pressure on the silicone resin should be proper. LED

(2) Components should not be mounted on warped (non coplanar) portion of PCB. After soldering, do not warp the circuit board. LED

(3) Do not apply mechanical force or excess vibration during the cooling process to normal temperature after soldering. Do not rapidly cool device after soldering.

4. Handling Precautions

4.1 Handling Precautions

(1) LED operating environment and sulfur element composition cannot be over 100PPM in the LED mating usage material. This is provided for informational purposes only and is not a warranty or endorsement.LED

(2) In order to prevent ex-ternal material from getting into the inside of LED, which may cause the malfunction of LED, the single content of Bromine element is required to be less than 900PPM,the single content of Chlorine elementis required to be less than 900PPM,the total content of Bromine element and Chlorine element in the external materials of the application products is required to be less than 1500PPM. This is provided for informational purposes only and is not a warranty or endorsement.

(3) VOCs (Volatile organic compounds) emitted from materials used in the construction of fixtures can penetrate silicone encapsulants of LEDs and discolor when exposed to heat and photonic energy. The result can be a significant loss of light output from the fixture. Knowledge of the properties of the materials selected to be used in the construction of fixtures can help prevent these issues. Refond advises against the use of any chemicals or materials that have been found or are suspected to have an adverse affect on device performance or reliability. To verify compatibility, Refond recommends that all chemicals and materials be tested in the specific application and environment for which they are intended to be used. Attaching LEDs, do not use adhesives that outgas organic vapor.

(4) Handle the component along the side surface by using forceps or appropriate tools; Do not directly touch or Handle the silicone lens surface, it may damage the internal circuitry.

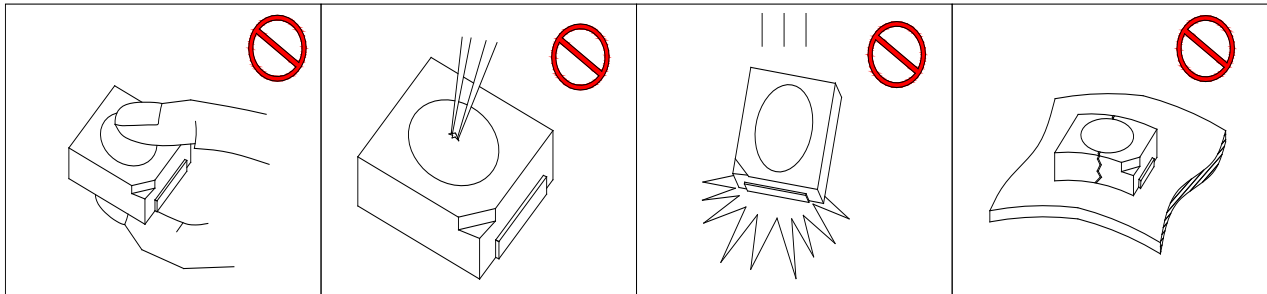

Fig 4-1Cautions

(5) In designing a circuit, the current through each LED can not exceed the absolute maximum rating specified for each LED. In the mean while, resistors for protection should be applied, otherwise slight voltage shift will cause big current change, burn out may happen. The driving circuit must be designed to allow forward voltage only when it is ON or OFF. If the reverse voltage is applied to LED, migration can be generated resulting in LED damage.

(6) Thermal Design is paramount importance because heat generation may result in the Characteristics decline, such as brightness decreased, Color change and so on. Please consider the heat generation of the LEDs when making the system design. LED

(7) Compared to standard encapsulants, silicone is generally softer, and the surface is more likely to attract dust, requiring special care during processing. In cases where a minimal level of dirt and dust particles cannot be guaranteed, a suitable cleaning solution must be applied to the surface after the soldering of components. Refond suggests using isopropyl alcohol for cleaning. In case other solvents are used, it must be assured that these solvents do not dissolve the package or resin. Ultrasonic cleaning is not recommended. Ultrasonic cleaning may cause damage to the

LED.

Table 4-1 Storage

Conditions		Temperature	Humidity	Time
Storage	Before Opening Aluminum Bag	30	75%	Within 1 Year From Date
	After Opening Aluminum Bag	30	60%	Recommended for use within 24 hours 24
Baking		60±5	-	24hours 24

(8) If the moisture absorbent material silica gel has faded away or the LEDs have exceeded the storage time, baking treatment should be performed after unpacking and based on the following condition 65 5 for above 24 hours.

±

If the package is flatulence or damaged, please notify the sales staff to assist.

(9) Similar to most Solid state devices; LEDs are sensitive to Electro-Static Discharge (ESD) and Electrical Over Stress (EOS).

(10) Other points for attention, please refer to our relevant information.



www.refond.com



Declare

This specification is written both in English and in Chinese and the latter is formal.