

SPECIFICATION

REFOND P/N

RF-P32E0-UBY-SR

Mass Product

Contents

1. Description

1.1 General Description	3
1.2 Features	3
1.3 Application	3
1.4 Package Dimension	4
1.5 Product P/F60m487* BDCET EMC /P A/CID 26/Lang (en-US)>BDC BT1 0 0 1 189.02A/CID 26/L	

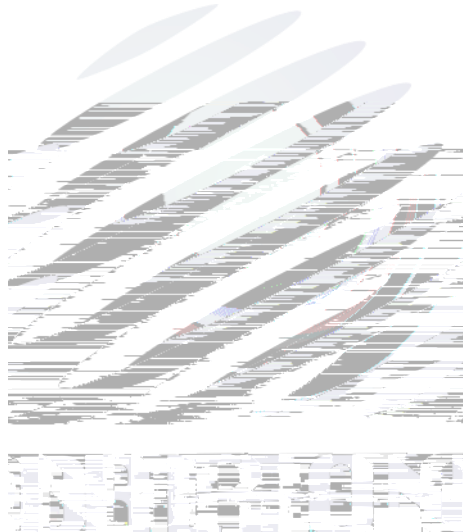

1. Description

1.1 General Description

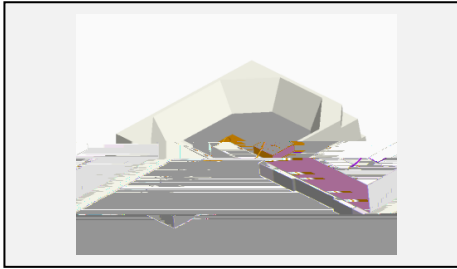

This production use the PLCC-2 package outline size 2.8*3.5*0.65mm

2.8*3.5*0.65mm

1.2 Features

- ▶ PLCC package.
- ▶ Viewing angle:120° .
- ▶ Suitable for all SMT assembly and solder process.
- ▶ Available on tape and reel.
- ▶ Moisture sensitivity level: Level 3.
- ▶ RoHS compliant.

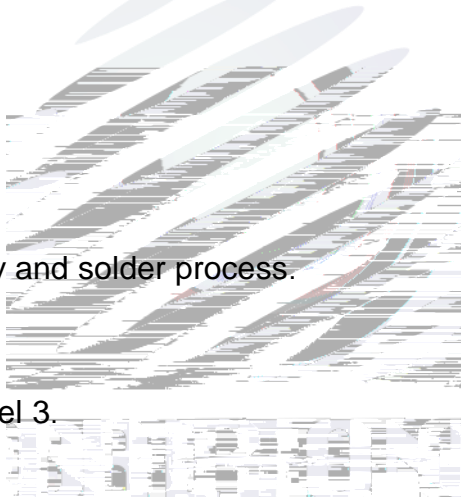

1.3 Application

- ▶ Ultraviolet disinfection .
- ▶ UV Curing .
- ▶ UV Ink Curing .
- ▶ Nail care.
- ▶ General use.

1.4 Package Dimension

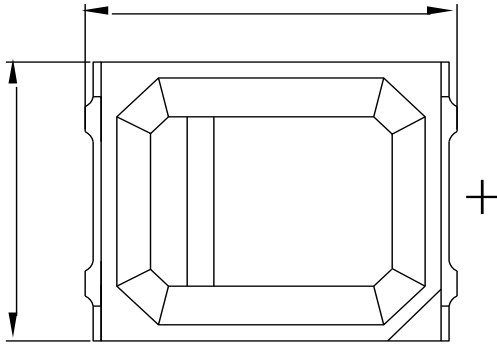

Fig.1-1 Top view

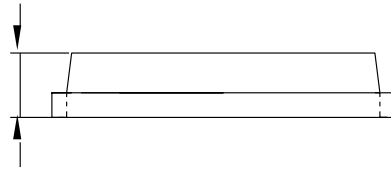

Fig.1-2 Side view

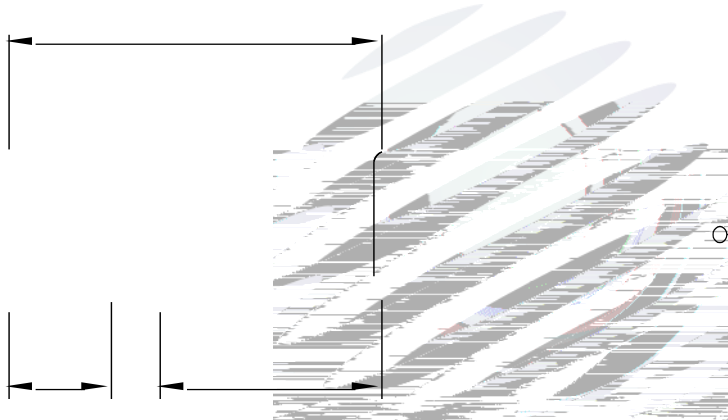

Fig.1-3 Bottom view

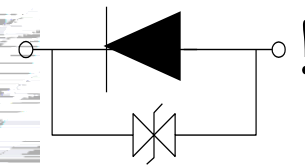

Fig.1-4 Polarity

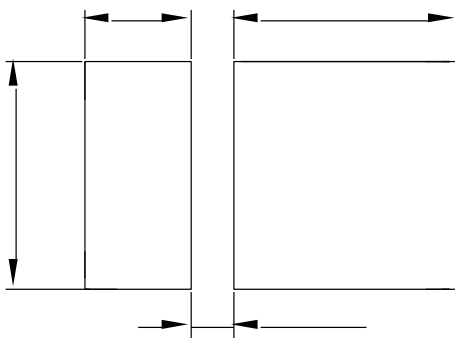

Fig.1-5 Soldering patterns

Notes

All dimensions units are millimeters.

All dimensions tolerances

1.5 Product Parameters

Table 1-1 Electrical / Optical Characteristics at Ts=25°C

Item	Symbol	Test Condition	Code	Value			Unit
				Min.	Typ	Max.	
Forward Voltage	V_F	$I_F=150mA$	B11	3.0	---	3.2	V
			B12	3.2	---	3.4	
			B13	3.4	3.5	3.6	
			B14	3.6	---	3.8	
Reverse Current	I_R	$V_R=5V$	---	---	---	10	μA
Total radiant flux	Φ_e	$I_F=150mA$	1B26	90	---	112	mW
			1B27	112	130	140	
			1B28	140	---	180	
			1B29	180	---	224	
Peak wavelength	λ_p	$I_F=150mA$	UA54	365	---	370	nm
			UA55	370	---	375	
Viewing Angle	2 θ 1/2	$I_F=150mA$	---	---	120	---	deg
Thermal Resistance.	R_{THJ-S}	$I_F=150mA$	---	---	45	---	$^{\circ}W$

Table 1-2 Absolute Maximum Ratings at Ts=25°C

Parameter	Symbol	Rating	Units
Maximum Power Dissipation	P_D	0.7	W
Peak Forward Current	I_{FP}	180	mA
Reverse Voltage	V_R	5	V
Electrostatic Discharge (HBM)	E_{SD}	1000	V
Operating Temperature	T_{OPR}	-40 ~ +85	
Storage Temperature	T_{OPR}	-40 ~ +100	
Junction Temperature	T_J	95	

Notes

1. The above forward voltage measurement allowance tolerance is $\pm 0.1V$.
2. The above wavelength measurement allowance tolerance is $\pm 2nm$.
3. The above radiation flux measurement allowance tolerance $\pm 10\%$.
4. Care is to be taken that power dissipation does not exceed the absolute maximum rating of the product.
5. All measurements were made under the standardized environment of Refond.
6. When the LEDs are in operation the maximum current should be decided after measuring the package temperature, junction temperature should not exceed the maximum rate
7. ESD yield is over 90% at 2000V ESD (HBM). ESD protection during products handing is needed.

1.6 Typical optical characteristics curves

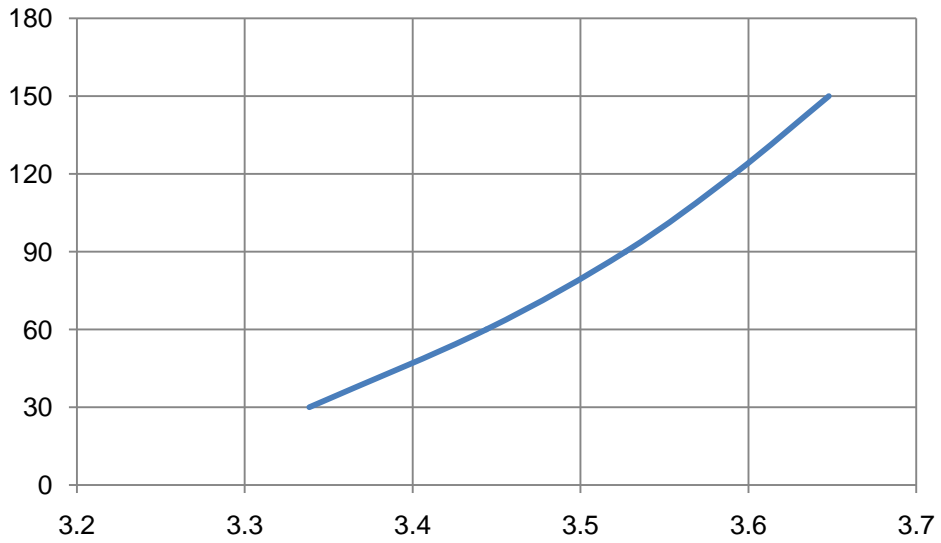

Fig.1- Forward Voltage Vs. Forward Current

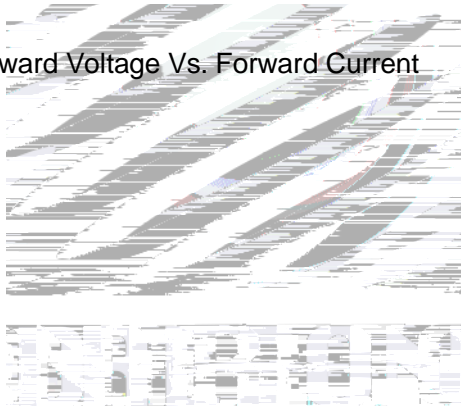

Fig.2- Forward Current Vs. Relative Power

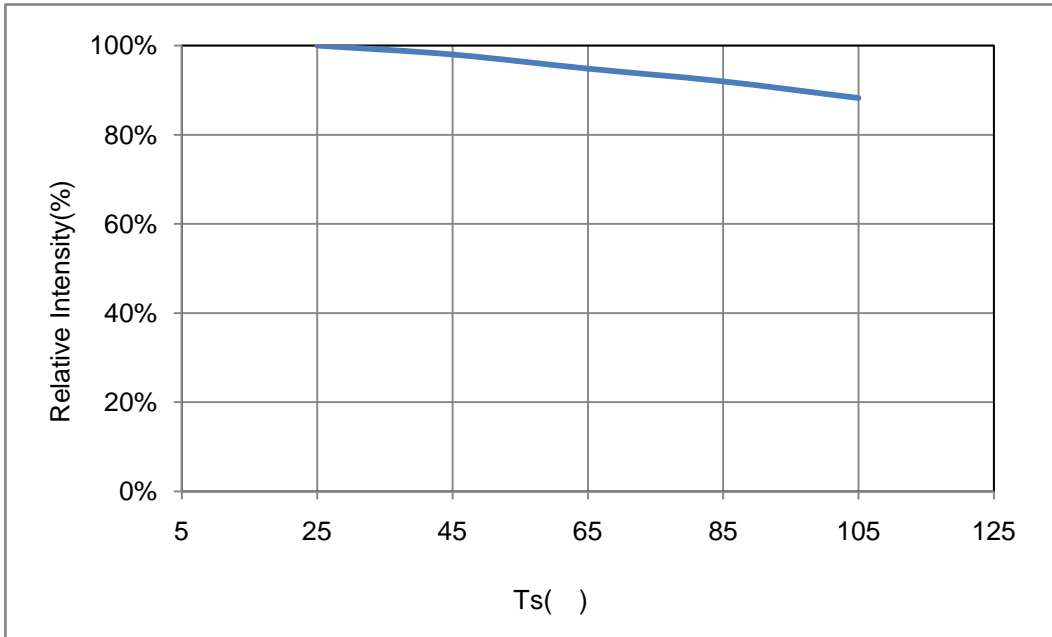

Fig.3-Solder Temperature VS. Relative Power

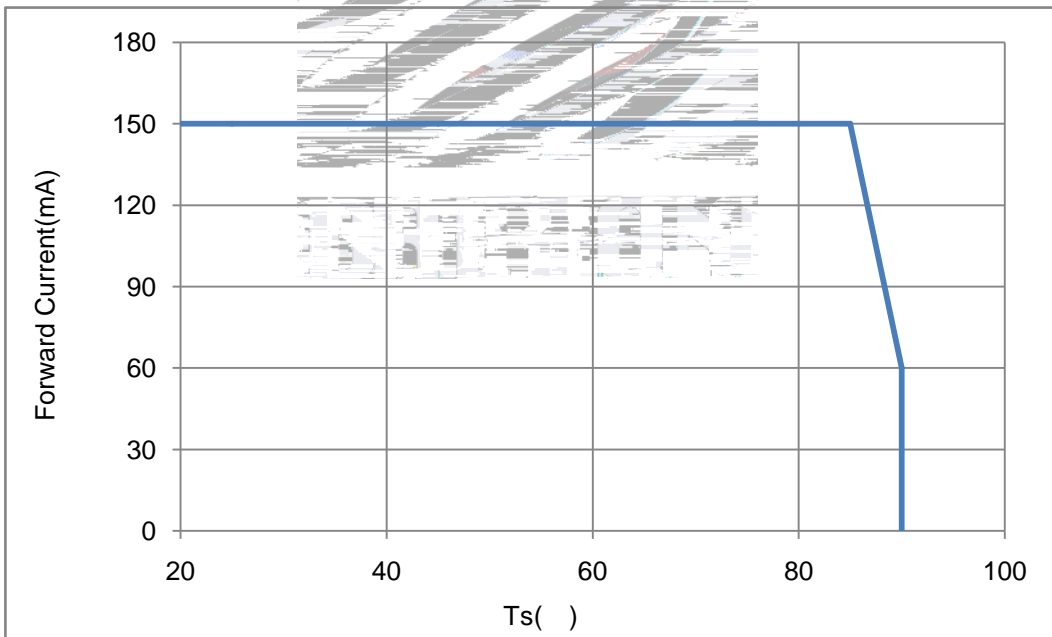

Fig.4-Ts Temperature VS. Forward Current

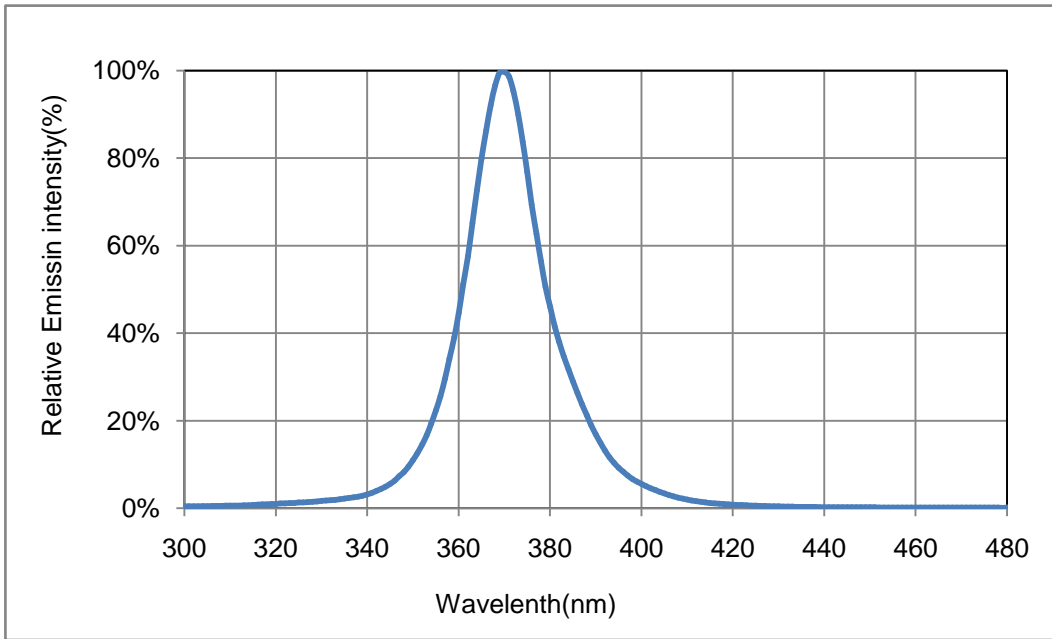

Fig.5-Spectrum Distribution

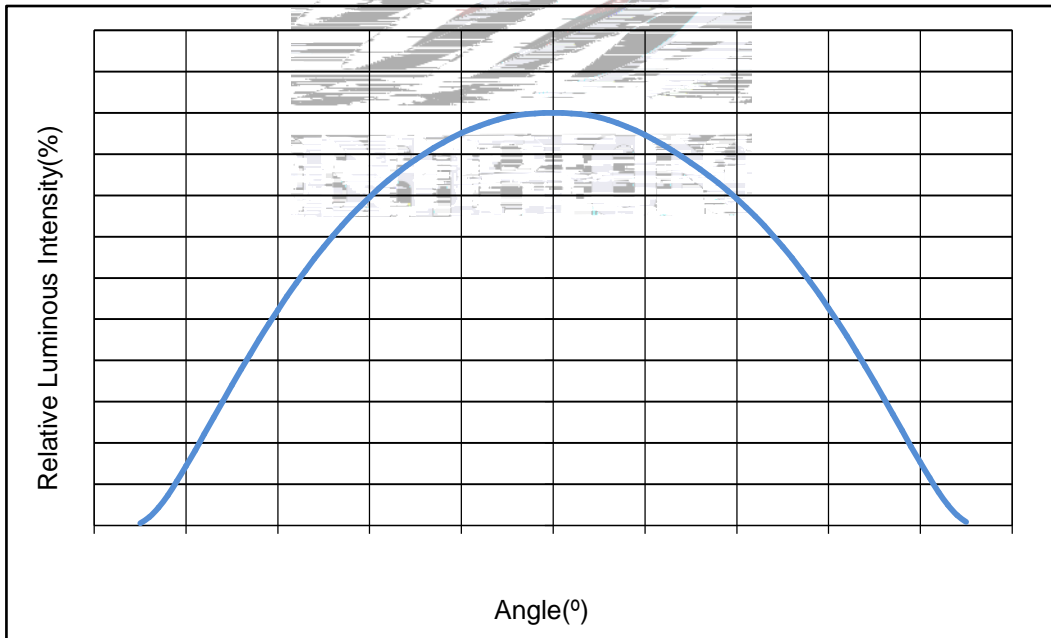

Fig.6- Radiation Diagram

2. Packaging

2.1 Packaging Specification

Package:4000pcs/reel.

2.1.1 Carrier Tape Dimension

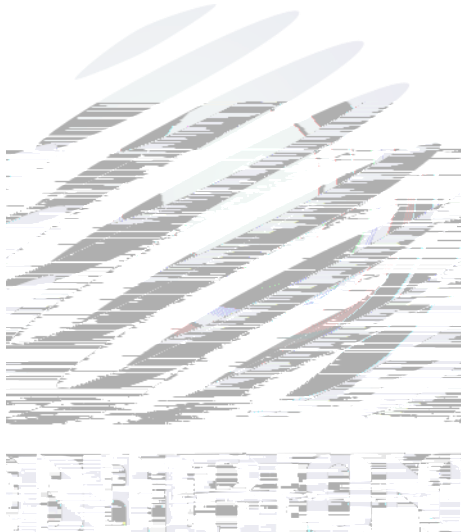

2.1.3 Label Form Specification

Label Form Specification

Fig. 2-3 Label Form Specification

2.2

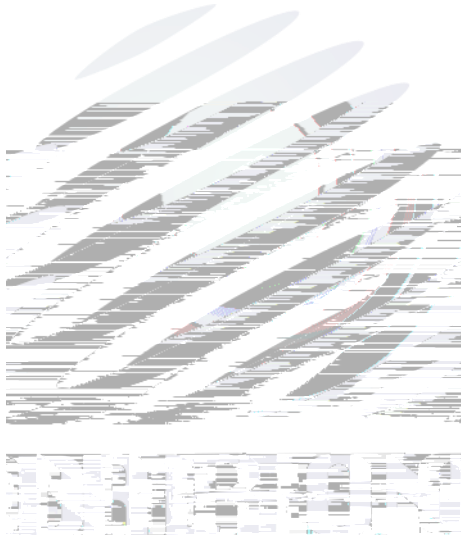

2.3 Cardboard Box

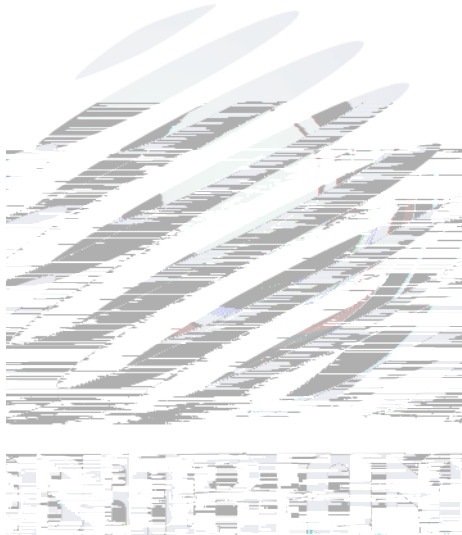

2.5 Criteria For Judging Damage

Table 2-4 Criteria For Judging Damage

Test Items	Symbol	Test Condition	Criteria For Judgement	
			Min.	Max.
Forward Voltage	V_F	$I_F=150\text{mA}$	-	U.S.L*)x1.1
Reverse Current	I_R	$V_R = 5\text{V}$	-	U.S.L*)x2.0
Total radiant flux	Φ_e	$I_F=150\text{mA}$	L.S.L*)x0.7	-

Notes

- 1.U.S.L: Upper standard level L.S.L: Lower standard level
2. The above reliability tests is based on the verification of a single/strip LED of Refond's existing experimental platform, the reliability experiment was taken under good heat dissipation conditions. when customers applies the LED to the series and parallel circuit, should take consideration of all the factors such as the current, voltage distribution, heat dissipation and others.
- 3.The technical information shown in the data sheets is limited to the typical characteristics and circuit examples of the referenced products. It does not constitute the warranting of industrial property nor the granting of any license.

3. SMT Reflow Soldering Instructions SMT 回流焊说明

3.1 SMT Reflow Soldering Instructions SMT

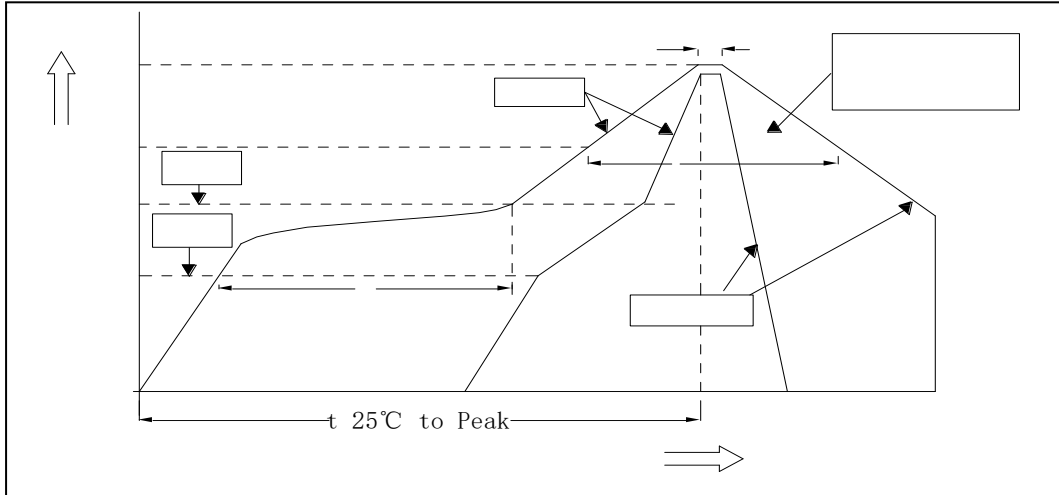

Fig.3-1 SMT Reflow Soldering Instructions

Table 3-1 SMT Reflow Soldering Instructions

Average temperature rise speed	T_{smax} T_P	Max 3 °C/ s	3 °C/
Preheating: minimum temperature	(T_{smin})	150 °C	
Preheating: Max temperature	(T_{smax})	200 °C	
Preheating: Time	T_{smin} T_{smax}	60s-120s	60 - 120
Time limited to maintain high temperature: the temperature (T_L)		217 °C	
Time limited to maintain high temperature: The Time (t_L)		Max 60s	60
Peak /Classification of temperature:	/ (T_P)	260 °C	
Time limit classification of peak temperature time t_p		Max 10s	10
Hold time within 5 °C with the actual peak temperature (T_P) 5 °C		Max 30s	30
Cooling speed		Max 6 °C/ s	6 °C/
Needed time from 25 °C to T_p 25 °C		Max 8 minutes	8

Notes

(1)Reflow soldering should not be done more than twice. If more than 24 hours between the two solderings , LED will be damaged.

(2)When soldering , do not put stress on the LEDs during heating.

3.1.1 Soldering Iron

(1) When do soldering by hand, keep the temperature of iron below less 300 less than 3 seconds

(2) Soldering by hand should be done only one time.

3.1.2 Repairing

Repairing should not be done after the LEDs have been soldered. When repairing is unavoidable,a double-head soldering iron should be used (as below figure). It should be confirmed in advance whether the characteristics of LEDs will or not be damaged by repairing.

LED

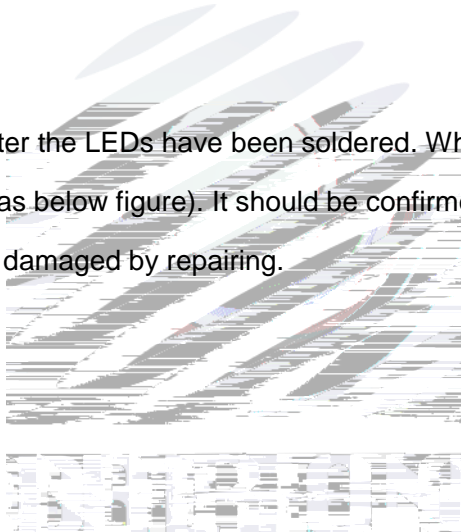

3.1.3 Cautions

(1) The encapsulated material of the LEDs is silicone. Therefore the LEDs have a soft surface on the top of package. The pressure to the top surface will be impacted on the reliability of the LEDs. Precautions should be taken to avoid the strong pressure on the encapsulated part. So when use the picking up nozzle, the pressure on the silicone resin should be proper. LED

(2) Components should not be mounted on warped (non coplanar) portion of PCB. After soldering, do not warp the circuit board.LED

(3) Do not apply mechanical force or excess vibration during the cooling process to normal temperature after soldering. Do not rapidly cool device after soldering.

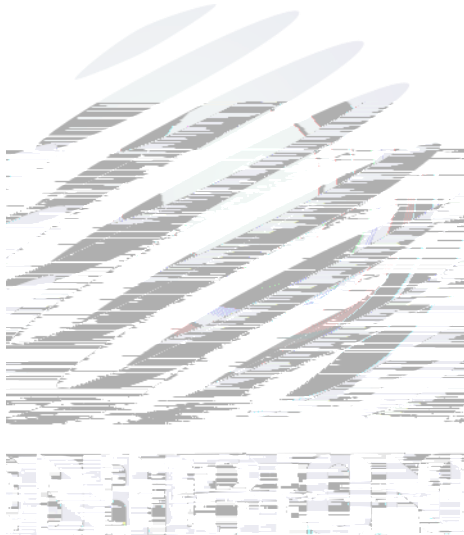

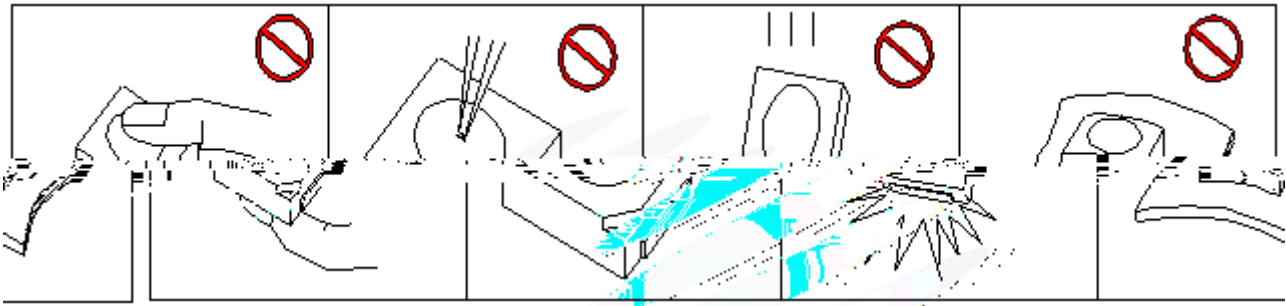
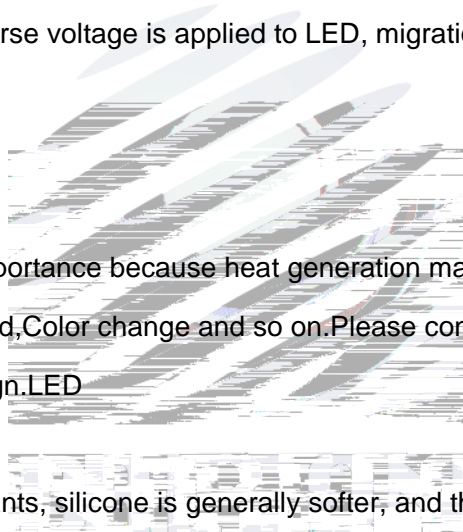

Fig 4-1 Operate Method

(5) In designing a circuit, the current through each LED can not exceed the absolute maximum rating specified for each LED. In the meanwhile, resistors for protection should be applied, otherwise slight voltage shift will cause big current change, burn out may happen. The driving circuit must be designed to allow forward voltage only when it is ON or OFF. If the reverse voltage is applied to LED, migration can be generated resulting in LED damage.



(6) Thermal Design is paramount importance because heat generation may result in the Characteristics decline, such as brightness decreased, Color change and so on. Please consider the heat generation of the LEDs when making the system design. LED

(7) Compared to standard encapsulants, silicone is generally softer, and the surface is more likely to attract dust, requiring special care during processing. In cases where a minimal level of dirt and dust particles cannot be guaranteed, a suitable cleaning solution must be applied to the surface after the soldering of components. Refond suggests using isopropyl alcohol for cleaning. In case other solvents are used, it must be assured that these solvents do not dissolve the package or resin. Ultrasonic cleaning is not recommended. Ultrasonic cleaning may cause damage to the LED.

Table 4-1 Storage

Conditions		Temperature	Humidity	Time
Storage	Before Opening Aluminum Bag	30	75%	Within 1 Year From Date
	After Opening Aluminum Bag	30	60%	24hours
Baking		60 5	-	24hours

(8) If the moisture absorbent material – silica gel – has faded away or the LEDs have exceeded the storage time, baking treatment should be performed after unpacking and based on the following condition 65 5 for above 24 hours.

If the package is flatulence or damaged, please notify the sales staff to assist.

(9) Similar to most Solid state devices; LEDs are sensitive to Electro-Static Discharge (ESD) and Electrical Over Stress (EOS).

(10) When using this product, you need to take good care to prevent it from causing harm to eyes and human body.

(11) Other points for attention, please refer to our relevant information.

Version History/

Date	Revisor	Version	Verifier	Remarks
2020-09-20		E0		



Declare

This specification is written both in English and in Chinese and the latter is formal.