

SPECIFICATION

LT P/N

LT3014WH-A-Q

Mass Product



- 1. Description
 - 1.1 General Description
 - 1.2 Features ..
 - 1.3 Application
 - 1.4 Package Dimension
 - 1.5 Product Parameters
 - 1.6 Bin Range Of For
(IF=20mA).....
 - 1.7 Typical Optical Char
- 2. Packaging .
 - 2.1 Packaging Specifica
 - 2.1.1 Carrier Tape Dime
 - 2.1.2 Reel Dimension
 - 2.1.3 Label Form Specil
 - 2.2 Moisture Resistant I
 - 2.3 Cardboard Box
 - 2.4 Reliability Test Item:
 - 2.5 Criteria For Judging
- 3. SMT Reflow Solderin
 - 3.1 SMT Reflow Solderi
- 4. Handling Precautions
 - 4.1 Handling Precautior



1.1 Generall

The White LED

Product Packag

1.2 Feature:

y P

y V

y S

y A

y M

y R

1.3

y

1.4

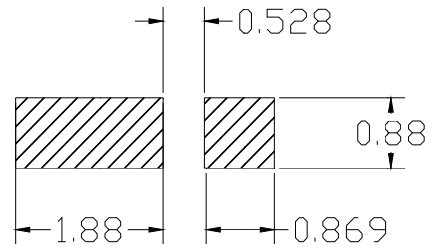
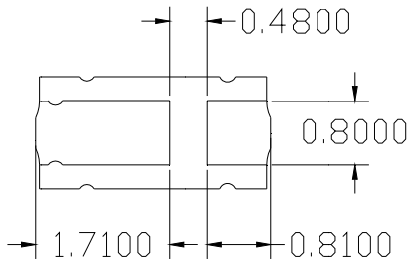
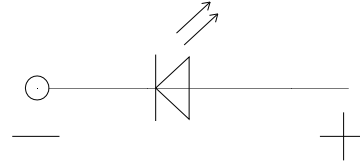
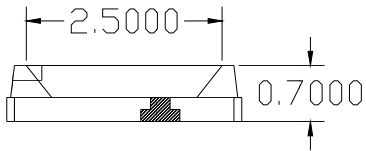
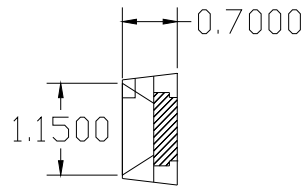
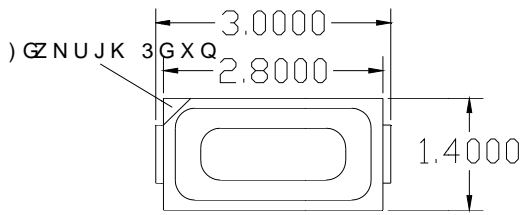

5 H F R H Q G H R G L V L Q G S

Notes

All dimensions units are millimeters

All dimensions tolerances are $\pm 0.1\text{mm}$ unless otherwise noted.

1.5 Product Parameters

L

Noti

1. 1

2. T

3. The above ci

4. The above lu

5. Care is to be

6. All measurer

7. When the LEI
temperature,]

1.6 Bin Rai BIN

	% , 1
	P:
	P:
	P:

Table 1-4 Bin Range Of Forward Voltage

Bin	0 L Q	0 D [8 Q L W	& R Q L W L R Q
V0	2.7	2.8	V	IF=20mA
V1	2.8	2.9		
V2	2.9	3.0		
V3	3.0	3.1		
V4	3.1	3.2		
V5	3.2	3.3		
V6	3.3	3.4		
V7	3.4	3.5		

Notes

VF Tolerance: $\pm 0.03V$ @ IF= 20mA @ Ta=25

IV Tolerance: $\pm 3\%$ @ IF= 20mA @ Ta=25

Fig. 1-5 The C.I.E. 1931 Chromaticity Diagram:

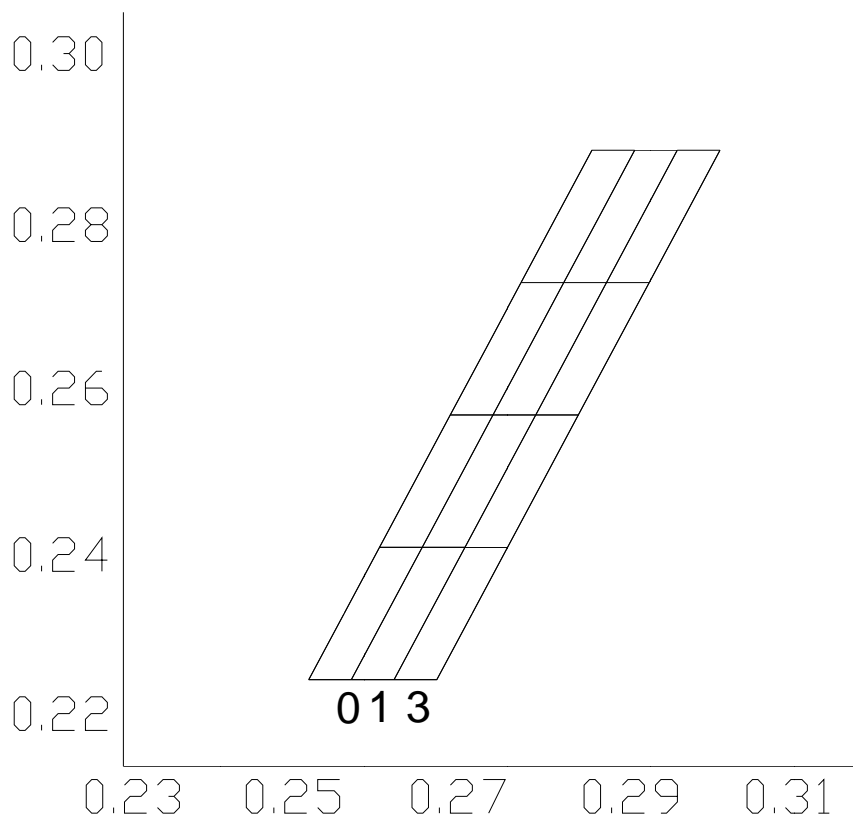

J13	0.2
	0.2
	0.2
	0.2
J16	0.2
	0.2
	0.2
	0.2
K15	0.2
	0.2
	0.2
	0.2
M14	0.2
	0.2
	0.2
	0.2

Notes

1 M

2 Tt

1.7 Typical Optical

8 K

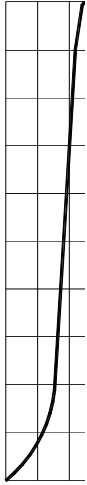

'SHOZTKSVKXGZ[X
) [XXKTZ

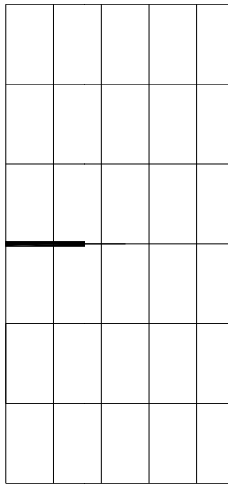

'SHOKTZ ZKS

'SHOKT:KSVKXGZ[XKX]G XJ <MRZG

,UX]GXJ<U <

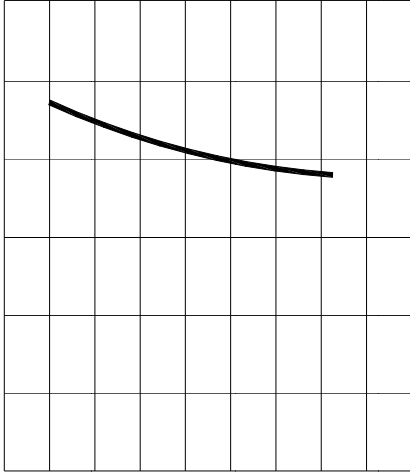

'SHOKTZ ZKXKXGG -

'SHOKT:KSVKXGZ[XKX]G XJ <MRZG
,R[^

8KRGZO\K 2[SOTU[Y,R[^

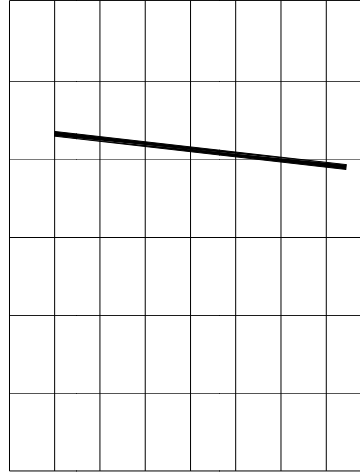

'SHOKTZ ZKXKXGG -

'RRU]GHRK ,UX]GXJ) [XXKTZ

*[Z_ 8GZO\URRU]GHRK,XJ) [XXKTZ

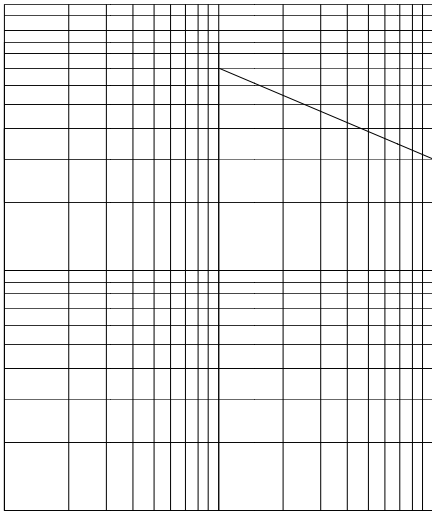

[Z_ 8GZO\URRU]GHRK,XJ) [XXKTZ

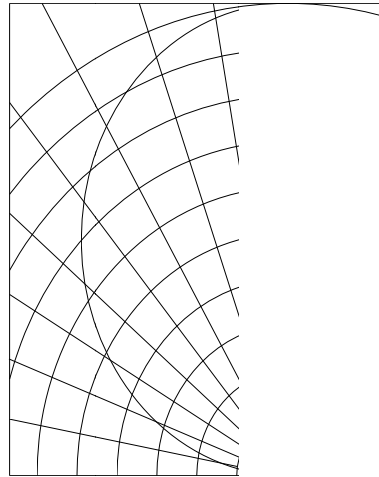

8KRGZO\K



ՔՁ

2.1

Կ

Te
RE

2.1.2 Label Form Specification

Table 2-2 Lable Map



Table 2-3 Label Form Specification

PART NO.	Part Number
BIN CODE	Bin Code
IV	Luminous intensity
V _F	Forward Voltage
WL	Wavelength
QTY	Packing Quantity
DATE	Made Date
LOT NO	Lot Number ©!Q'

2.2 Moisture Resistant Packing

Fig.2-4 Moisture Resistant Packing

2.3 Cardboard Box

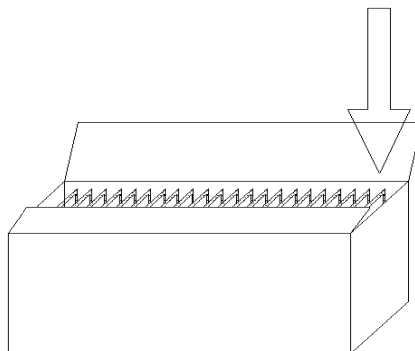

Fig.2-5 Cardboard Box

2.4 Reliability Test Items And Conditions

Table 2-6 Reliability Test Items And Conditions

Test Items	Test Condition	Time	Quantity	Ac/Re /
Reflow	Temp:260 max T=10 sec	---	20pcs.	0/1
Thermal Shock	-40 20min 9 10s 100 20min	100 cycle	20pcs.	0/1
High Temperature Storage	Temp:100	1000hrs.	20pcs.	0/1
Low Temperature Storage	Temp:-40	1000hrs.	20pcs.	0/1
Life Test	Ta=25 IF=20mA	1000hrs.	20pcs.	0/1
High Temperature and Humidity storage	60 / 90%RH	1000hrs.	20pcs.	0/1
Temperature Humidity Operation Life	IF=15mA 60 / 90%RH	500hrs	20pcs.	0/1

2.5 Criteria For Judging Damage

Table 2-7 Criteria For Judging Damage

Test Items	Symbol	Test Condition	Criteria For Judgement	
			Min.	Max.
Forward Voltage	V_F	$I_F=20mA$	-	$>U.S.L^*)x1.1$
Reverse Current	I_R	$V_R = 5V$	-	$>U.S.L^*)x2.0$
Luminous Flux	λ	$I_F=20mA$	$<L.S.L^*)x0.7$	-

Notes

- 1.U.S.L: Upper standard level L.S.L: Lower standard level
- 2.The above reliability tests is based on the verification of a single/strip LED of LT existing experimental platform,the reliability experiment was taken under good heat dissipation conditions. when customers applies the LED to the series and parallel circuit, should take consideration of all the factors such as the current, voltage distribution, heat dissipation and others.
- 3.The technical information shown in the data sheets is limited to the typical characteristics and circuit examples of the referenced products. It does not constitute the warranting of industrial property nor the granting of any license.

3. SMT Reflow Soldering Instructions SMT 3 WD y f

3.1 SMT Reflow Soldering Instructions

Fig.3-1 SMT Reflow Soldering Map

Fig.3-2 SMT Reflow Soldering Instructions SMT

Average temperature rise speed	T_{smax} T_P	5 °C/	Max 5 °C/ s
Preheating: minimum temperature	(T_{smin})	160 °C	
Preheating: Max temperature	(T_{smax})	260 °C	
Preheating: Time	T_{smin} T_{smax}	60 - 120	60s-120s
Time limited to maintain high temperature: the temperature	(T_L)	217 °C	
Time limited to maintain high temperature: The Time	(t_L)	60	Max 60s
Peak /Classification of temperature:	/ (T_P)	260 °C	
Time limit classification of peak temperature time	t_p	10	Max 10s
(T_P) 5 °C actual peak temperature (TP)	Hold time within 5 °C with the	30	Max 30s
Cooling speed		6 °C/	Max 6 °C
25 °C	Needed time from 25 °C to T_p	8	Max 8 minu

Notes

(1)Reflow soldering should not be done more than twice. If more than 24 hours between the two solderings , LED will be darr

24 LED

(2)Whensoldering , do not put stress on the LEDs during heating.

3.1.1 Soldering Iron

(1) When do soldering by hand, keep the temperature of iron below less 300 less than 3 seconds.

300 3

(2) Soldering by hand should be done only one time.

3.1.2 Repairing

Repairing should not be done after the LEDs have been soldered. When repairing is unavoidable, a double-head soldering iron should be used (as below figure). It should be confirmed in advance whether the characteristics of LEDs will or not be damaged by repairing.

LED #w'@ D C ÉB \$ C . %o ûN± \$ C, , ûN± µ+^ j' J÷ ,6B J Á ~ Ê.µAÚ!š 0 ĩ E P C P • ...LED bDá°(] >

3.1.3 Cautions # E ÁN⁻

(1) The encapsulated material of the LEDs is silicone. Therefore the LEDs have a soft surface on the top of package. The pressure to the top surface will be impacted on the reliability of the LEDs. Precautions should be taken to avoid the strong pressure on the encapsulated part. So when use the picking up nozzle, the pressure on the silicone resin should be proper. LED 7>û7, p.{ 7, ,>žM⁻

E¹Ež, +^ Ñ ? Á 7, %o>žM⁻ P § LED %M-], lš Ê ?N° Lh à óFµ f ^ ? Á ž, , %o µ+^ n j, , 7, %o>žM⁻, ° Á Ñ Ê e ! %o, ° >

(2) Components should not be mounted on warped (non coplanar) portion of PCB. After soldering, do not warp the circuit board. LED &¥* C?.'@ Ū ^ e (, ° PCB µ @ , '@ Ū • D , • C? . e Í4õ D%µ >

(3) Do not apply mechanical force or excess vibration during the cooling process to normal temperature after soldering. Do not rapidly cool device after soldering. #w'@ • D í aEý0A c , C?./ † Ī Ō Ō L Ñ , • C? . ?M= P , #w'@ D , C? . Gý+^%ö • í a , ° ĩ E >

4. Handling Pre caution s Ý ÷ µ+^# E ÁN⁻

4.1 Handli ng Preca utions Ý ÷ µ+^# E ÁN⁻

(1) LED operating environment and sulfur element composition cannot be over 100PPM in the LED mating usage material. This is provided for informational purposes only and is not a warranty or endorsement. LED ')á ' D LED F8Gf, ° † Ī c. j y3V L > (Ý F 3 C %C » Eý100PPM. F e 6 ` 0Aä , C ' 1 < ÷ C^ ū >

(2) In order to prevent ex-ternal material from getting into the inside of LED, which may cause the malfunction of LED, the single content of Bromine element is required to be less than 900PPM, the single content of Chlorine element is required to be less than 900PPM, the total content of Bromine element and Chlorine element in the external materials of the application products is required to be less than 1500PPM. This is provided for informational purposes only and is not a warranty or endorsement. p ¼Lh !" L +, (ÝC^F) LED »G FV F LED , ° Z , v :)á ' v+^ • , 1 • 1 • , < 6, ° \$ê y3V aH ? . "x E Ä 900PPM , < 6" e y3V aH ? . "x E Ä 900PPM , \$ê y3V D " e y3V q aH ū N±E Ä 1500PPM. F e 6 ` 0Aä , C ' 1 < ÷ C^ ū >

(3) VOCs (Volatile organic compounds) emitted from materials used in the construction of fixtures can penetrate silicone encapsulants of LEDs and discolor when exposed to heat and photonic energy. The result can be a significant loss of light output from the fixture. Knowledge of the properties of the materials selected to be used in the construction of fixtures can help prevent

these issues. LT advises against the use of a
affect on device performance or reliability. To
specific application and environment for which
organic vapor.

(4) Handle the component along the side surface
lens surface, it may damage the internal circuit.

(5) In designing a circuit, the current through
meanwhile, resistors for protection should be
happen. The driving circuit must be designed
to LED, migration can be generated resulting

(6) Thermal Design is of paramount importance
brightness decreased, color change and so on
design. LED

(7) Compared to standard enclosures
special care during processing.
solution must be applied to the
case other solvents are used, it
not recommended. Ultrasonic cleaning

Table 4-1 Storage

Conditions		Temperature	Humidity	Time
Storage Ø ^	Before Opening Aluminum Bag	"30	"75%	Within 1 Year F
	After Opening Aluminum Bag	"30	"60%	
Baking		60±5	-	

(8) If the moisture absorbent materialp· silica gelp, has faded away or the LEDs have exceeded the treatment should be performed after unpacking and based on the following conditionp· 65±5p, fc
60±5 24

If the package is flatulence or damaged, please notify the sales staff to assist.

(9) Similar to most Solid state devices; LEDs are sensitive to Electro-Static Discharge (ESD) and E
LED

Version History/

Date	Revisor	Version	Verifier	Remarks
2019/11/1		E/0		