

SPECIFICATION

LT P/N

LT216WH-A-Q

Mass Product



Contents

1. Description	3
1.1 General Description	3
1.2 Features	3
1.3 Application	3
1.4 Package Dimension	4
1.5 Product Parameters	4
1.6 Bin Range Of Forward Voltage and Luminous Intensity (IF=20mA)	BIN
(IF=20mA)	6
1.7 Typical Optical Characteristics Curves	10
2. Packaging	11
2.1 Packaging Specification	11
2.1.1 Carrier Tape Dimension	11
2.1.2 Label Form Specification	12
2.2 Moisture Resistant Packing	12
2.3 Cardboard Box	12
2.4 Reliability Test Items And Conditions	13
2.5 Criteria For Judging Damage	14
3. SMT Reflow Soldering Instructions SMT	15
3.1 SMT Reflow Soldering Instructions SMT	15
4. Handling Precautions	17
4.1 Handling Precautions	17

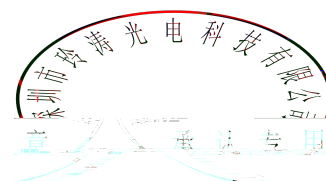

1.1 General Descriptio

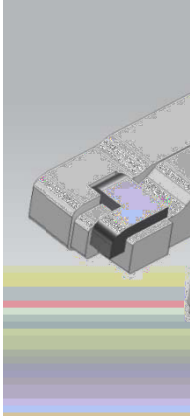

The White LED, which was
Product Package:

1.2 Features

PLCC Package.PLCCs

Wide viewing

Suitable for

Available on

Moisture sen

RoHS compl

1.3 Applica

LCD Back l

Mobile Phor

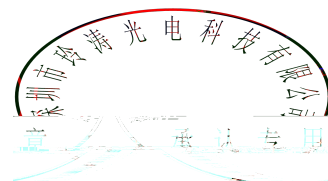

1.4 Package Dimension

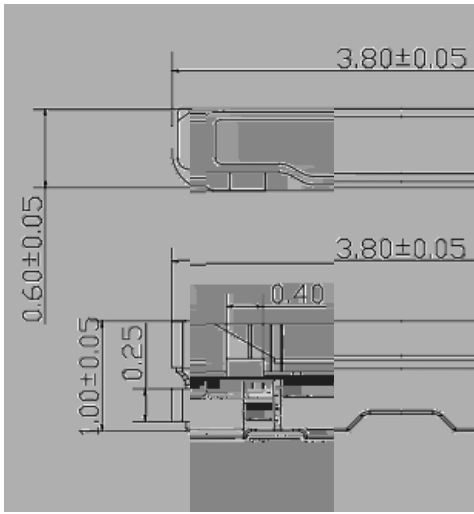

Notes

All dimensions units are millimeter.

All dimensions tolerances are 0.1

1.5 Product Parameters

Table 1-1 Electrical

Item
Forward Voltage
Reverse Current
Luminous Intensi ty
Viewing Angle

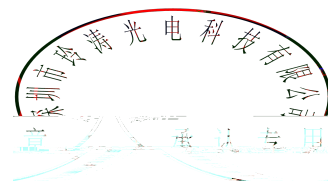

Parame
Forwa
Peak For

Notes

1. 1/10 Duty cy
2. The above fc
3. The above ci
4. The above lu
5. Care is to be
6. All measurer
7. When the LE temperature,

1.6 Bin Range Of Forward Voltage and Luminous Intensity (IF=20mA)

BIN (IF=20mA)

Table 1-3 Bin Range Of Luminous Intensity

BIN CODE	IF=20mA Test			
	Mn(mcd)	Max(mcd)	Mn(lm)	Max(lm)
30	2150	2250	6.00	6.25
31	2250	2350	6.25	6.50
32	2350	2450	6.50	6.75
33	2450	2550	6.75	7.00
34	2550	2650	7.00	7.25
35	2650	2750	7.25	7.50
36	2750	2850	7.50	7.75
37	2850	2950	7.75	8.00
38	2950	3050	8.00	8.25
39	3050	3150	8.25	8.50
40	3150	3250	8.50	8.75
41	3250	3350	8.75	9.00
42	3350	3450	9.00	9.25
43	3450	3550	9.25	9.50
44	3550	3650	9.50	9.75
45	3650	3750	9.75	10.0
46	3750	3850	10.00	10.25

Table 1-4 Bin Range Of Forward Voltage

BIN CODE	Mn	Max.	Unit	Condition
V0	2.7	2.8	V	IF=20mA
V1	2.8	2.9		
V2	2.9	3.0		
V3	3.0	3.1		
V4	3.1	3.2		
V5	3.2	3.3		

Notes

VF Tolerance: $\pm 0.03V$ @ IF= 20mA @ Ta=25

IV Tolerance: $\pm 3%$ @ IF= 20mA @ Ta=25

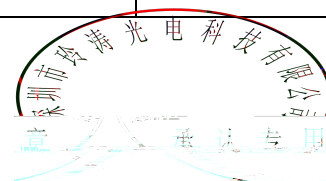

Fig. 1-5 The C.I.E. 1931 Chromaticity Diagram:

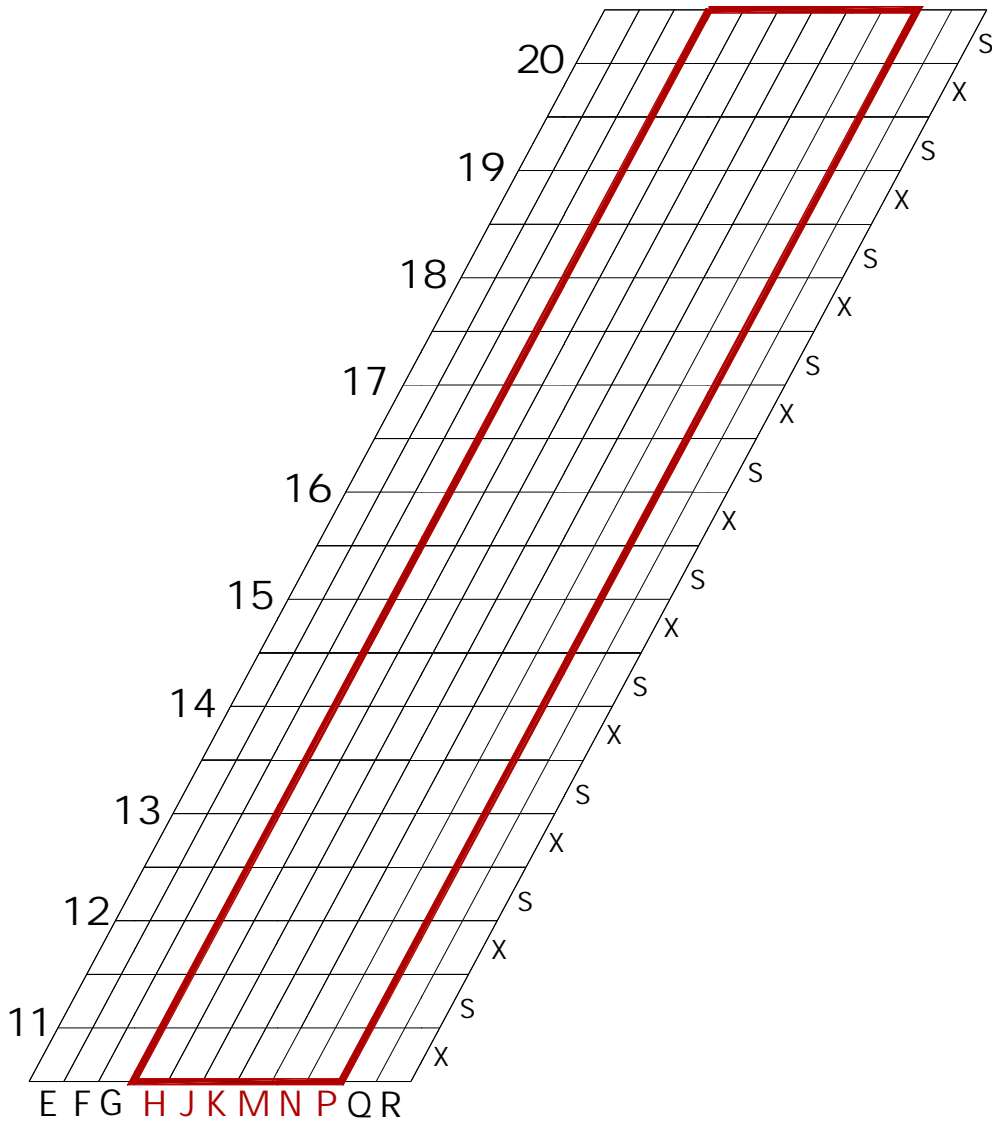

Table 1-6 Bin Range of Chromaticity Coordinates Block

H11X	0.2302	0.1944	J11X	0.2354	0.1944	K11X	0.2406	0.1944	M11X	0.2458	0.1944	N11X	0.2510	0.1944	P11X	0.2562	0.1944
	0.2345	0.2023		0.2397	0.2023		0.2449	0.2023		0.2501	0.2023		0.2553	0.2023		0.2605	0.2023
	0.2397	0.2023		0.2449	0.2023		0.2501	0.2023		0.2553	0.2023		0.2605	0.2023		0.2657	0.2023
	0.2354	0.1944		0.2406	0.1944		0.2458	0.1944		0.2510	0.1944		0.2562	0.1944		0.2614	0.1944
H11S	0.2345	0.2023	J11S	0.2397	0.2023	K11S	0.2449	0.2023	M11S	0.2501	0.2023	N11S	0.2553	0.2023	P11S	0.2605	0.2023
	0.2388	0.2102		0.2440	0.2102		0.2492	0.2102		0.2544	0.2102		0.2596	0.2102		0.2648	0.2102
	0.2440	0.2102		0.2492	0.2102		0.2544	0.2102		0.2596	0.2102		0.2648	0.2102		0.2700	0.2102
	0.2397	0.2023		0.2449	0.2023		0.2501	0.2023		0.2553	0.2023		0.2605	0.2023		0.2657	0.2023
H12X	0.2388	0.2102	J12X	0.2440	0.2102	K12X	0.2492	0.2102	M12X	0.2544	0.2102	N12X	0.2596	0.2102	P12X	0.2648	0.2102
	0.2431	0.2181		0.2483	0.2181		0.2535	0.2181		0.2587	0.2181		0.2639	0.2181		0.2691	0.2181
	0.2483	0.2181		0.2535	0.2181		0.2587	0.2181		0.2639	0.2181		0.2691	0.2181		0.2743	0.2181

	0.2440	0.2102		0.2492	0.2102		0.2544	0.2102
H12S	0.2431	0.2181	J12S	0.2483	0.2181	K12S	0.2535	0.2181
	0.2474	0.2260		0.2526	0.2260		0.2578	M12S 0.2102
	0.2526	0.2260		0.2578	0.2260		0.2630	
	0.2483	0.2181		0.2535	0.2181		0.2587	
H13X	0.2474	0.2260	J13X	0.2526	0.2260	K13X	0.2578	
	0.2517	0.2339		0.2569	0.2339		0.2621	
	0.2569	0.2339		0.2621	0.2339		0.2673	
	0.2526	0.2260		0.2578	0.2260		0.2630	
H13S	0.2517	0.2339	J13S	0.2569	0.2339	K13S	0.2621	
	0.2560	0.2418		0.2612	0.2418		0.2664	
	0.2612	0.2418		0.2664	0.2418		0.2716	
	0.2569	0.2339		0.2621	0.2339		0.2673	
H14X	0.2560	0.2418	J14X	0.2612	0.2418	K14X	0.2664	
	0.2603	0.2497		0.2655	0.2497		0.2707	
	0.2655	0.2497		0.2707	0.2497		0.2759	
	0.2612	0.2418		0.2664	0.2418		0.2716	
H14S	0.2603	0.2497	J14S	0.2655	0.2497	K14S	0.2707	
	0.2646	0.2576		0.2698	0.2576		0.2750	
	0.2698	0.2576		0.2750	0.2576		0.2802	
	0.2655	0.2497		0.2707	0.2497		0.2759	
H15X	0.2646	0.2576	J15X	0.2698	0.2576	K15X	0.2750	
	0.2689	0.2655		0.2741	0.2655		0.2793	
	0.2741	0.2655		0.2793	0.2655		0.2845	
	0.2698	0.2576		0.2750	0.2576		0.2802	
H15S	0.2689	0.2655	J15S	0.2741	0.2655	K15S	0.2793	
	0.2732	0.2734		0.2784	0.2734		0.2836	
	0.2784	0.2734		0.2836	0.2734		0.2888	
	0.2741	0.2655		0.2793	0.2655		0.2845	
H16X	0.2732	0.2734	J16X	0.2784	0.2734	K16X	0.2836	
	0.2775	0.2813		0.2827	0.2813		0.2879	
	0.2827	0.2813		0.2879	0.2813		0.2931	
	0.2784	0.2734		0.2836	0.2734		0.2888	
H16S	0.2775	0.2813	J16S	0.2827	0.2813	K16S	0.2879	
	0.2818	0.2892		0.2870	0.2892		0.2922	
	0.2870	0.2892		0.2922	0.2892		0.2974	
	0.2827	0.2813		0.2879	0.2813		0.2931	
H17X	0.2818	0.2892	J17X	0.2870	0.2892	K17X	0.2922	
	0.2861	0.2971		0.2913	0.2971		0.2965	
	0.2913	0.2971		0.2965	0.2971		0.3017	
	0.2870	0.2892		0.2922	0.2892		0.2974	
H17S	0.2861	0.2971	J17S	0.2913	0.2971	K17S	0.2965	
	0.2904	0.3050		0.2956	0.3050		0.3008	

	0.2956	0.3050		0.3008	0.3050		0.3060	0.3050		0.3112	0.3050		0.3164	0.3050		0.3216	0.3050		
	0.2913	0.2971		0.2965	0.2971		0.3017	0.2971		0.3069	0.2971		0.3121	0.2971		0.3173	0.2971		
H18X	0.2904	0.3050	J18X	0.2956	0.3050	K18X	0.3008	0.3050	M18X	0.3060	0.3050	N18X	0.3112	0.3050	P18X	0.3164	0.3050		
	0.2947	0.3129		0.2999	0.3129		0.3051	0.3129		0.3103	0.3129		0.3155	0.3129		0.3155	0.3129	0.3207	0.3129
	0.2999	0.3129		0.3051	0.3129		0.3103	0.3129		0.3155	0.3129		0.3112	0.3050		0.3164	0.3050	0.3259	0.3129
	0.2956	0.3050		0.3008	0.3050		0.3060	0.3050		0.3112	0.3050		0.3164	0.3050		0.3216	0.3050	0.3216	0.3050
H18S	0.2947	0.3129	J18S	0.2999	0.3129	K18S	0.3051	0.3129	M18S	0.3103	0.3129	N18S	0.3155	0.3129	P18S	0.3207	0.3129		
	0.2990	0.3208		0.3042	0.3208		0.3094	0.3208		0.3146	0.3208		0.3198	0.3208		0.3198	0.3208	0.3250	0.3208
	0.3042	0.3208		0.3094	0.3208		0.3146	0.3208		0.3198	0.3208		0.3250	0.3208		0.3250	0.3208	0.3302	0.3208
	0.2999	0.3129		0.3051	0.3129		0.3103	0.3129		0.3155	0.3129		0.3207	0.3129		0.3259	0.3129	0.3259	0.3129
H19X	0.2990	0.3208	J19X	0.3042	0.3208	K19X	0.3094	0.3208	M19X	0.3146	0.3208	N19X	0.3198	0.3208	P19X	0.3250	0.3208		
	0.3033	0.3287		0.3085	0.3287		0.3137	0.3287		0.3189	0.3287		0.3241	0.3287		0.3241	0.3287	0.3293	0.3287
	0.3085	0.3287		0.3137	0.3287		0.3189	0.3287		0.3241	0.3287		0.3293	0.3287		0.3345	0.3287	0.3345	0.3287
	0.3042	0.3208		0.3094	0.3208		0.3146	0.3208		0.3198	0.3208		0.3250	0.3208		0.3302	0.3208	0.3302	0.3208
H19S	0.3033	0.3287	J19S	0.3085	0.3287	K19S	0.3137	0.3287	M19S	0.3189	0.3287	N19S	0.3241	0.3287	P19S	0.3293	0.3287		
	0.3076	0.3366		0.3128	0.3366		0.3180	0.3366		0.3232	0.3366		0.3284	0.3366		0.3284	0.3366	0.3336	0.3366
	0.3128	0.3366		0.3180	0.3366		0.3232	0.3366		0.3284	0.3366		0.3336	0.3366		0.3388	0.3366	0.3388	0.3366
	0.3085	0.3287		0.3137	0.3287		0.3189	0.3287		0.3241	0.3287		0.3293	0.3287		0.3345	0.3287	0.3345	0.3287

Notes

- 1 Measurement uncertainty of the color coordinates: ± 0.003 .
- 2 The new white dustbin refers to the application of small backlight standard.

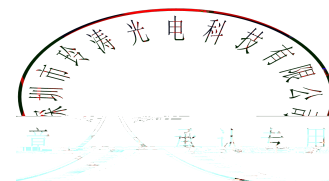

1.7 Typical Optical Characteristics Curves

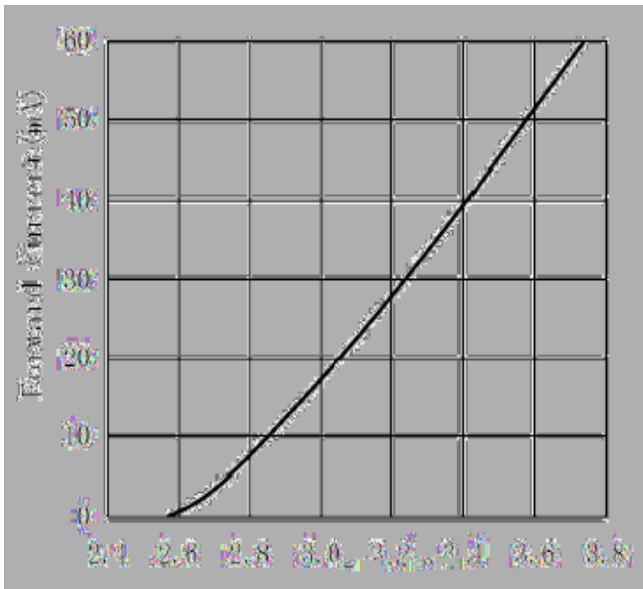

Fig. 1-13 Forward Voltage Vs Forward Current

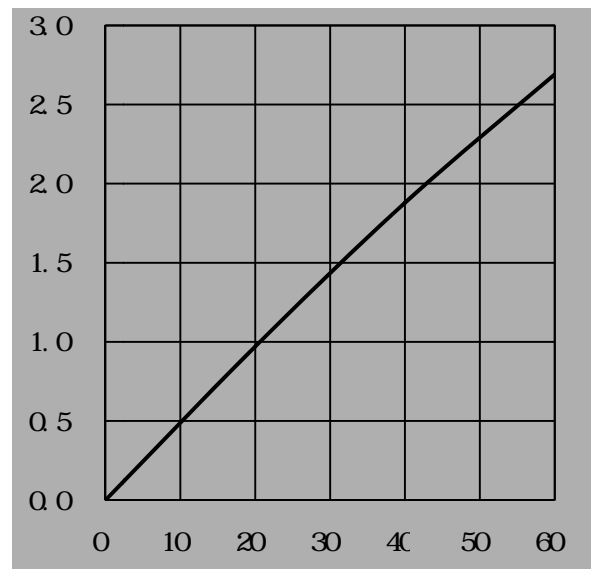

Fig. 1-14 Forward Current Vs Relative Intensity

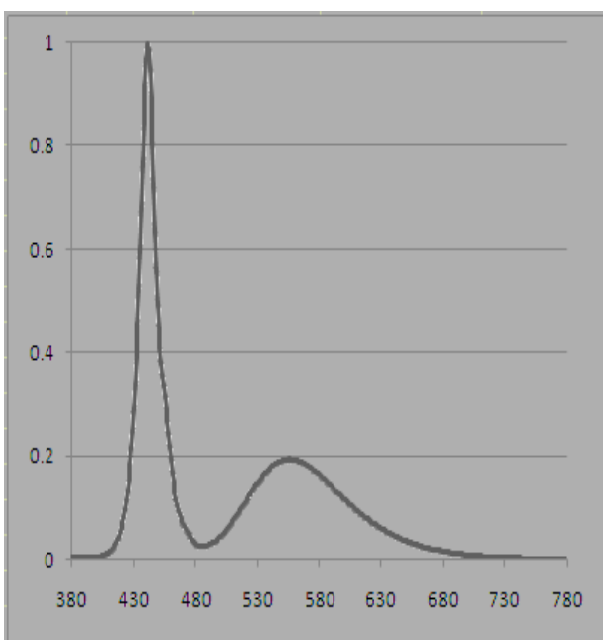

Fig. 1-16 Spectrum Distribution

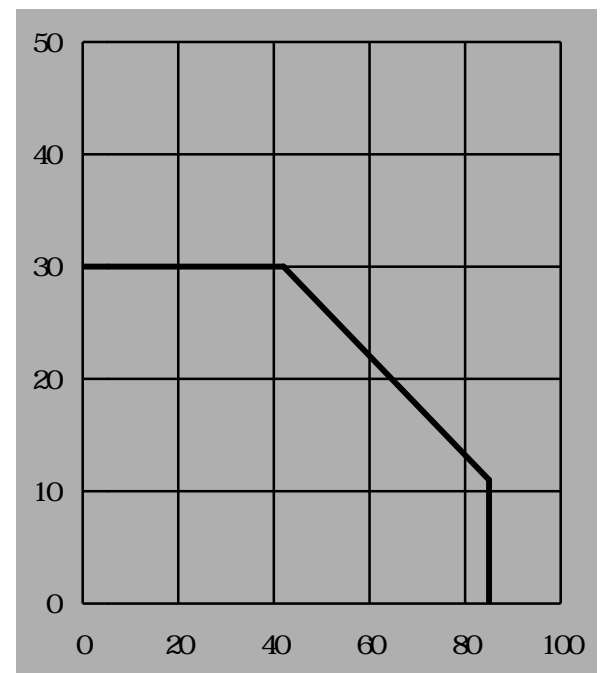
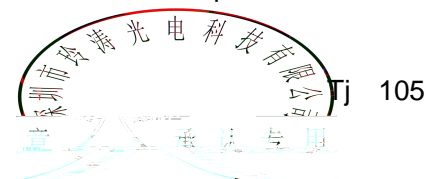

Fig. 1-15 Solder Temperature Vs Forward Current



2. Packaging

Packaging Specification

A. Package: 5000pcs/reel. 5000pcs

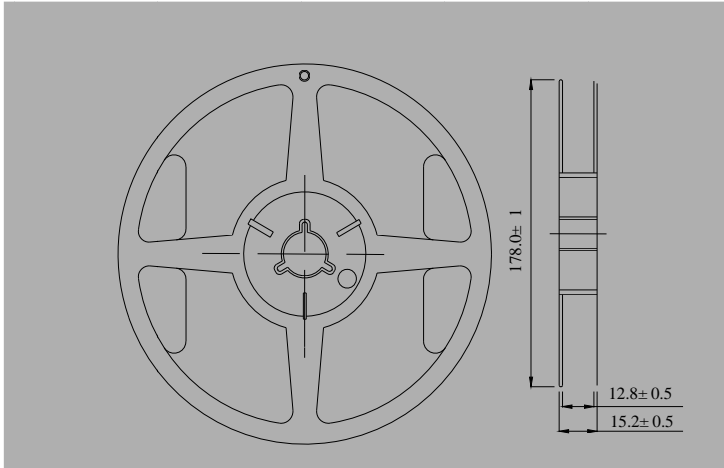

B. Package: 10000pcs/reel. 10000pcs

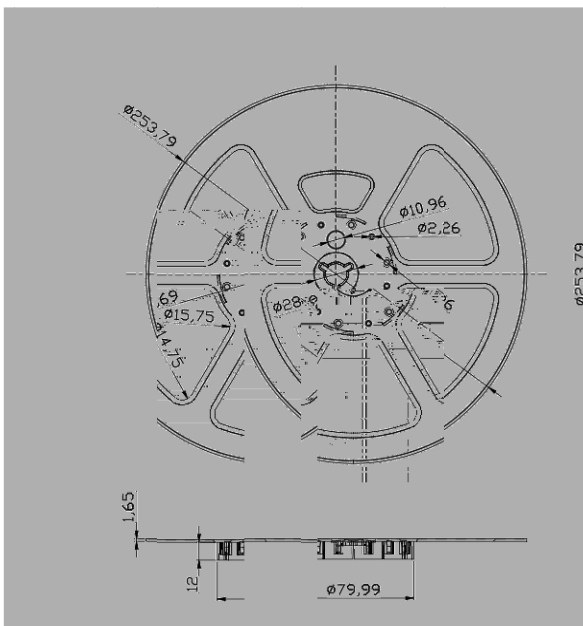

Notes

When the quantity is less than 10000pcs/roll, the quantity is 5000pcs

2.1.1 Carrier Tape Dimension

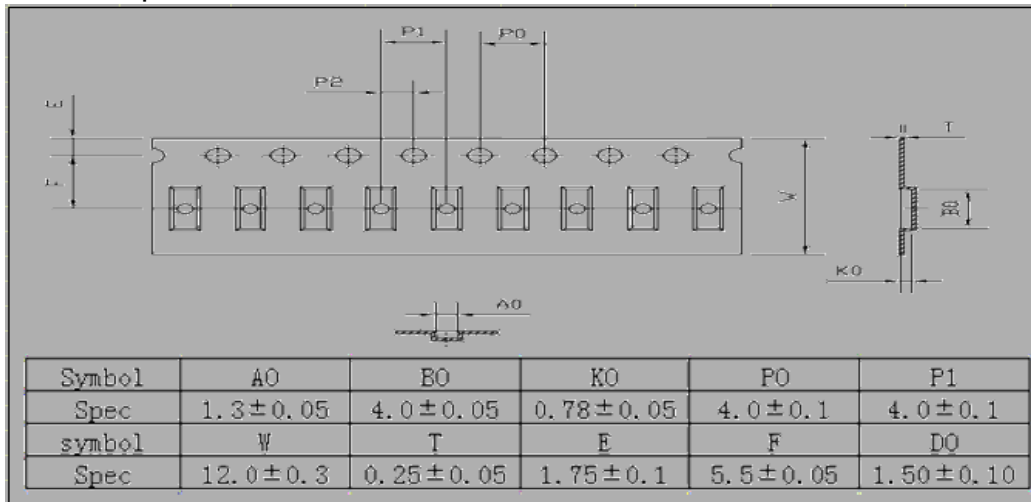

Fig.2-1 Carrier Tape Dimension

Notes

The tolerances unless mentioned ±2.0mm. Unit : mm

2.1.2 Label Form Specification

Table 2-2 Lable Map



Table 2-3 Label Form Specification

PART NO.	Part Number
BIN CODE	Bin Code
IV	Luminous intensity
V _F	Forward Voltage
WL	Wavelength
QTY	Packing Quantity
DATE	Made Date
LOT NO	Lot Number

2.2 Moisture Resistant Packing

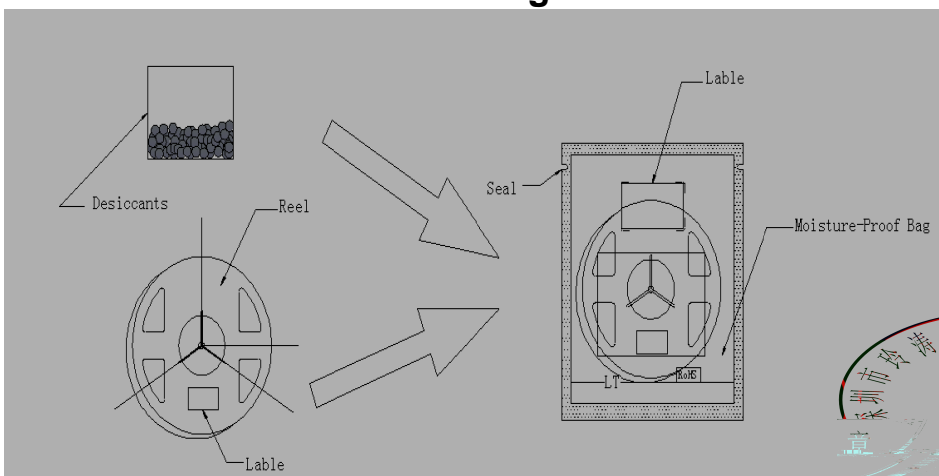
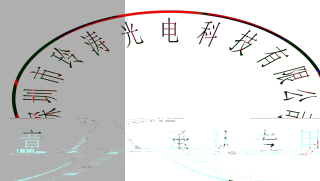

Fig.2-4 Moisture Resistant Packing



2.3 Cardboard Box

2.4 Reliability Test

Tab

TestItems
Reflow
Thermal Shock
High Temperature Stor
Low Temperature Stor
Lif
High Te and Hum
High Te and High h

2.5 Criteria For Judging Damage

Table 2-7 Criteria For Judging Damage

Test Items	Symbol	Test Condition	Criteria For Judgement	
			Min.	Max.
Forward Voltage	V_F	$I_F=20mA$	-	$>U.S.L^*) \times 1.1$
Reverse Current	I_R	$V_R = 5V$	-	$>U.S.L^*) \times 2.0$
Luminous Flux		$I_F=20mA$	$<L.S.L^*) \times 0.7$	-

Notes

- 1.U.S.L: Upper standard level L.S.L: Lower standard level
- 2.The above reliability tests is based on the verification of a single/strip LED of LT existing experimental platform,the reliability experiment was taken under good heat dissipation conditions. when customers applies the LED to the series and parallel circuit, should take consideration of all the factors such as the current, voltage distribution, heat dissipation and others.
- 3.The technical information shown in the data sheets is limited to the typical characteristics and circuit examples of the referenced products. It does not constitute the warranting of industrial property nor the granting of any license.

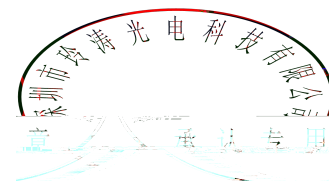

3. SMT Reflow Soldering Instructions SMT

3.1 SMT Reflow Soldering Instructions

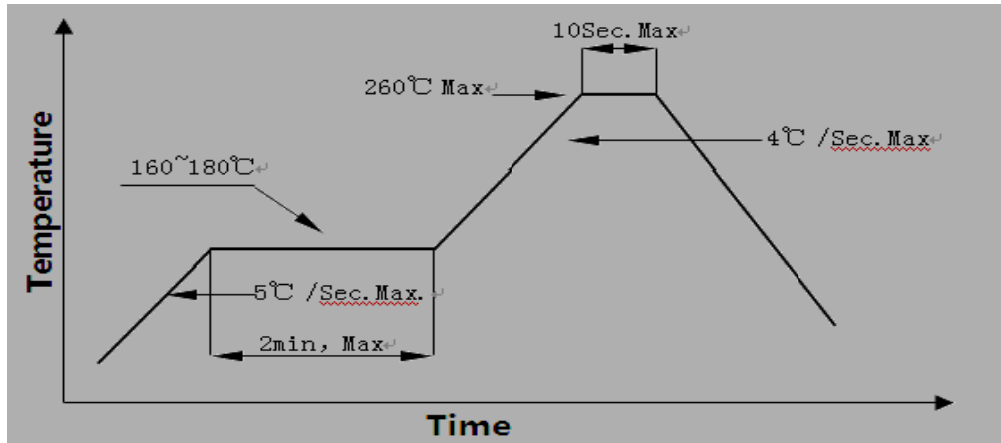

Fig.3-1 SMT Reflow Soldering Map

Fig.3-2 SMT Reflow Soldering Instructions SMT

Average temperature rise speed	T_{smax}	T_P	5 °C/	Max 5 °C/ s
Preheating: minimum temperature	(T_{smin})		160 °C	
Preheating: Max temperature	(T_{smax})		260 °C	
Preheating: Time	T_{smin}	T_{smax}	60 - 120	60s-120s
Time limited to maintain high temperature: the temperature		(T_L)	217 °C	
Time limited to maintain high temperature: The Time		(t_L)	60	Max 60s
Peak /Classification of temperature:	/	(T_P)	260 °C	
Time limit classification of peak temperature time		t_p	10	Max 10s
(T_P)	5 °C	Hold time within 5 °C with the	30	Max 30s
actual peak temperature (TP)				
Cooling speed			6 °C/	Max 6 °C
25 °C		Needed time from 25 °C to T_p	8	Max 8 minu

Notes

(1)Reflow soldering should not be done more than twice. If more than 24 hours between the two solderings , LED will be damaged.

(2)Whensoldering , do not put stress on the LEDs during heating.

3.1.1 Soldering Iron

(1) When do soldering by hand, keep the temperature of iron below less 300 less than 3 seconds.

(2) Soldering by hand should be done only one time.

3.1.2 Repairing

Repairing should not be done after the LEDs have been soldered. When repairing is unavoidable,a double-head soldering iron should be used (as below figure). It should be confirmed in advance whether the characteristics of LEDs will or not be damaged by repairing.

LED

3.1.3 Cautions

(1) The encapsulated material of the LEDs is silicone. Therefore the LEDs have a soft surface on the top of package. The pressure to the top surface will be impacted on the reliability of the LEDs. Precautions should be taken to avoid the strong pressure on the encapsulated part. So when use the picking up nozzle, the pressure on the silicone resin should be proper. LED

(2) Components should not be mounted on warped (non coplanar) portion of PCB. After soldering, do not warp the circuit board.LED

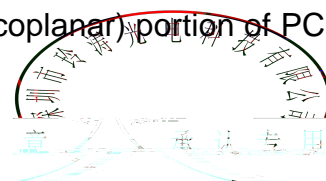

(3) Do not apply mecha
temperature after solde

4.1 Handling Preca

(1) LED operating enviro
LED mating usage mate
or endorsement. LED

(2) In order to prevent e
malfunction of LED, the
900PPM, the single con
content of Bromine ele
products is required to
and is not a warranty or

(3) VOCs (Volatile orga
can penetrate silicone e
energy. The result can l
properties of the materi
these issues. LT advise
are suspected to have
verify compati
application ar
adhesives the

(4) Handle the component along the side surface by using forceps or appropriate tools; do not directly touch or Handle the silicone lens surface, it may damage the internal circuitry.

(5) In designing a circuit, the current through each LED must exceed the absolute maximum rating specified for each LED. In the meanwhile, resistors for protection should be applied, otherwise slight voltage shift will cause big current change, burn out may happen. The driving circuit must be designed to allow forward voltage only when it is ON or OFF. If the reverse voltage is applied to LED, migration can be generated resulting in LED damage.

(6) Thermal Design is paramount importance because heat generation may result in the Characteristics decline, such as brightness decreased, Color change and so on. Please consider the heat generation of the LEDs when making the system design. LED

(7) Compared to standard encapsulants, silicone is generally softer, and the surface is more likely to attract dust requiring special care during processing. In cases where a minimal level of dirt and dust particles cannot be guaranteed, a suitable cleaning solution must be applied to the surface after the soldering of components. LT suggests using isopropyl alcohol for cleaning. In case other solvents are used, it must be assured that these solvents do not dissolve the package or resin. Ultrasonic cleaning is not recommended. Ultrasonic cleaning may cause damage to the LED.

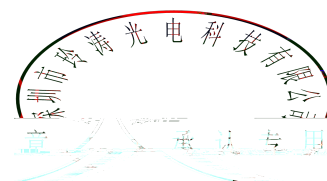

Table 4-1 Storage

Conditions		Temperature	Humidity	
Storage	Before Opening Aluminum Bag	30	75%	With
	After Opening Aluminum Bag	30	60%	
Baking		60 5	-	

(8) If the moisture absorbent material silica gel has faded away or the l
the storage time baking treatment should be performed after unpacking ;
following condition 65 5 for above 24 hours.

If the package is flatulence or damaged, please notify the sales staff to ass

(9) Similar to most Solid state devices; LEDs are sensitive to Ele
Electrical Over Stress (EOS).

Version History/

Date	Revisor	Version	Verifier	Remarks
2020/06/29		E/0		

