

□ R&D

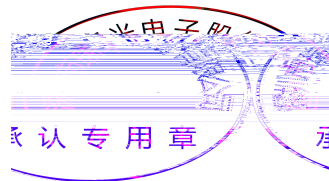

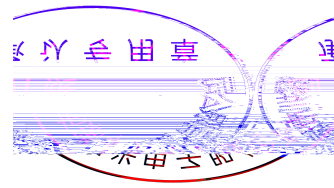

1.

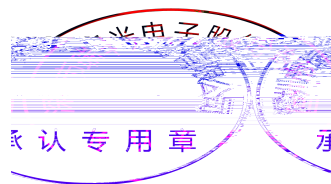

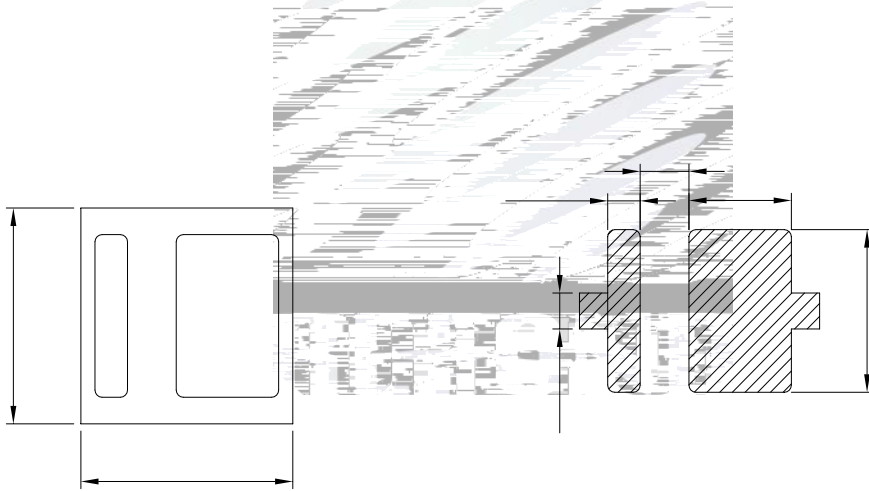
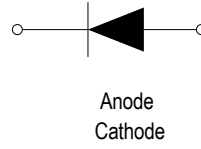
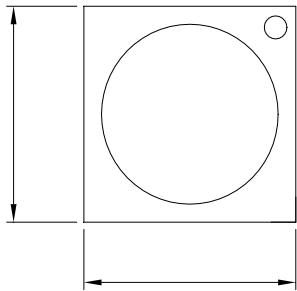

±

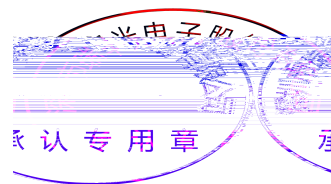

	$\lambda$					

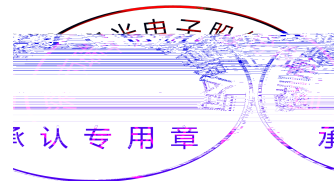
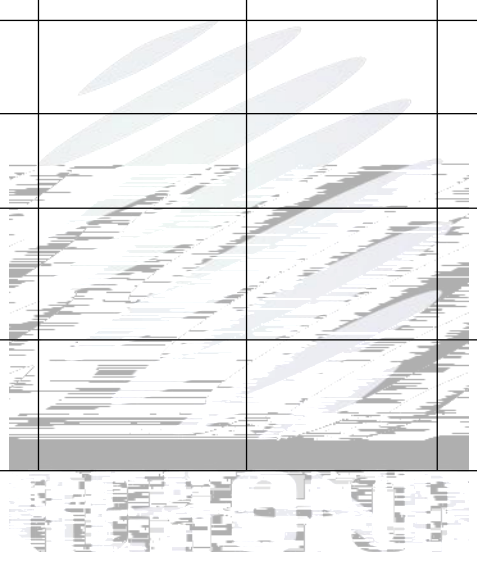



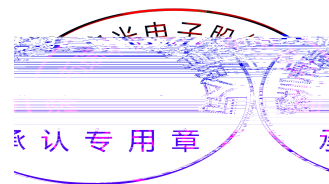
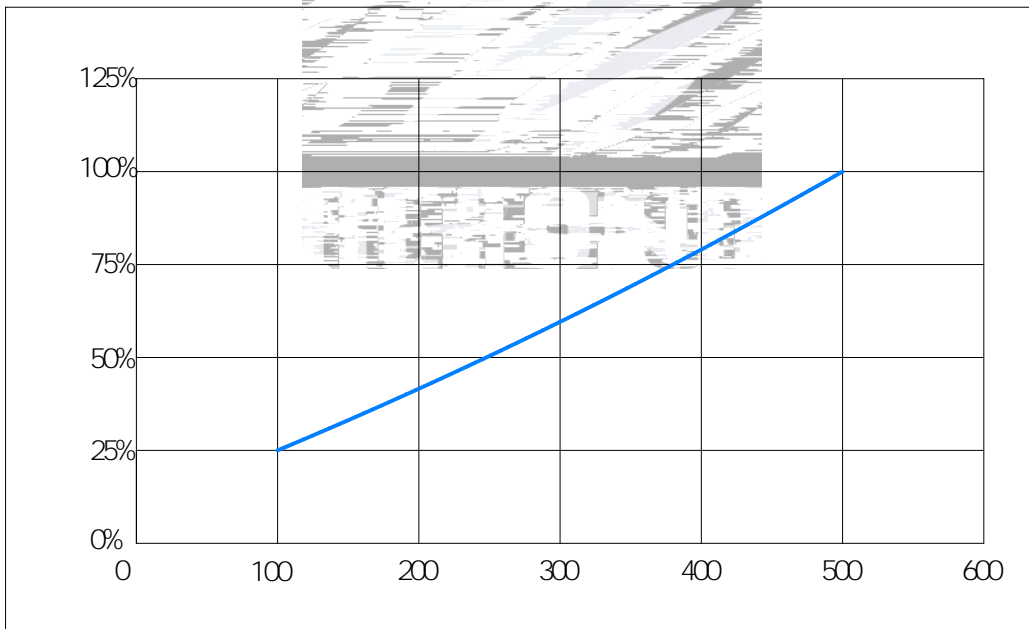
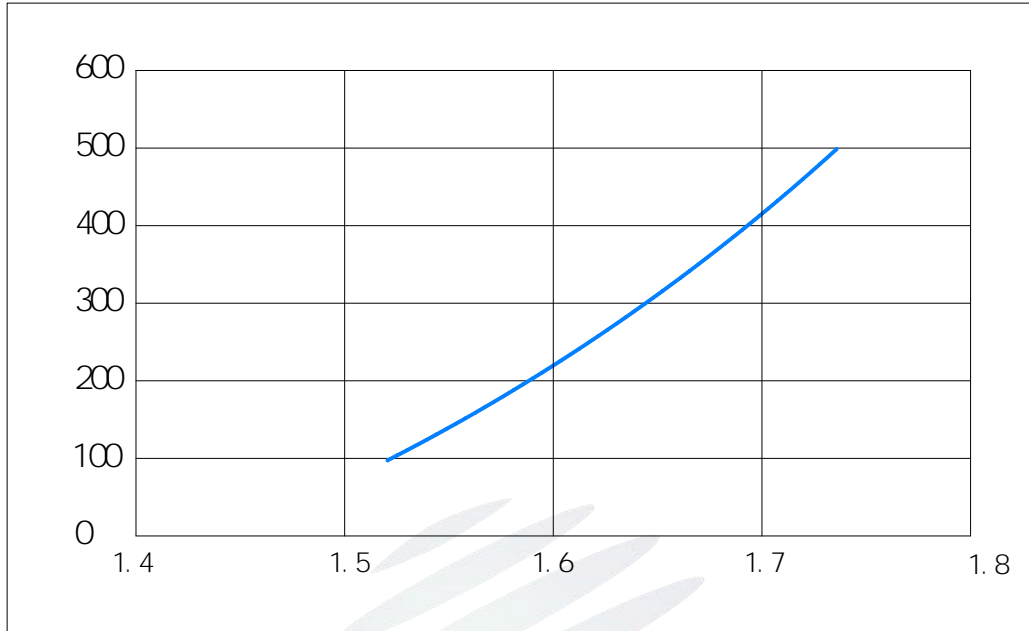

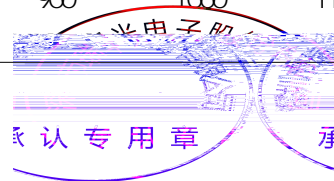
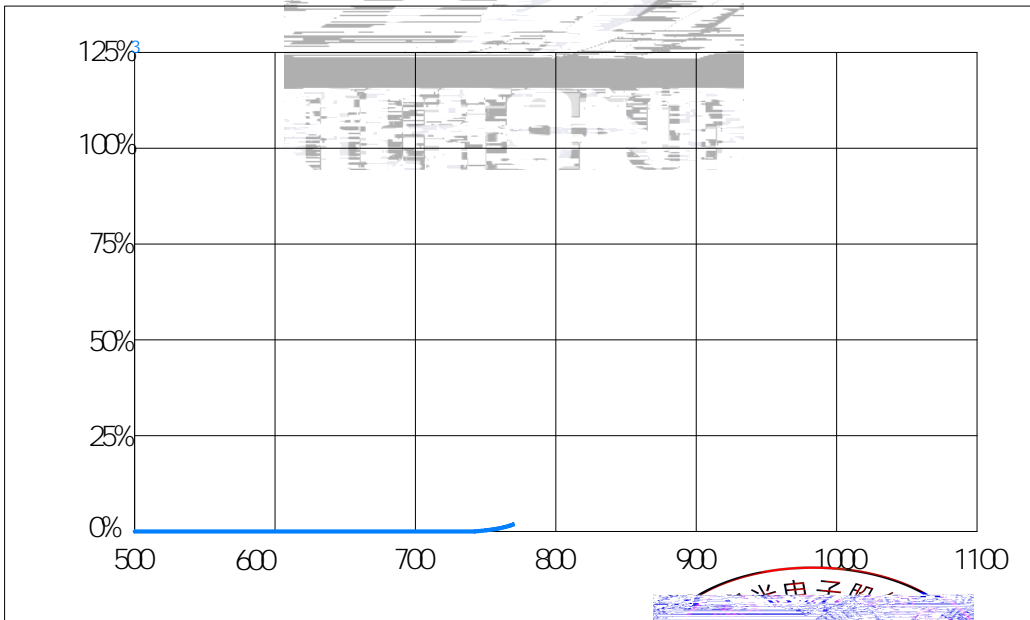
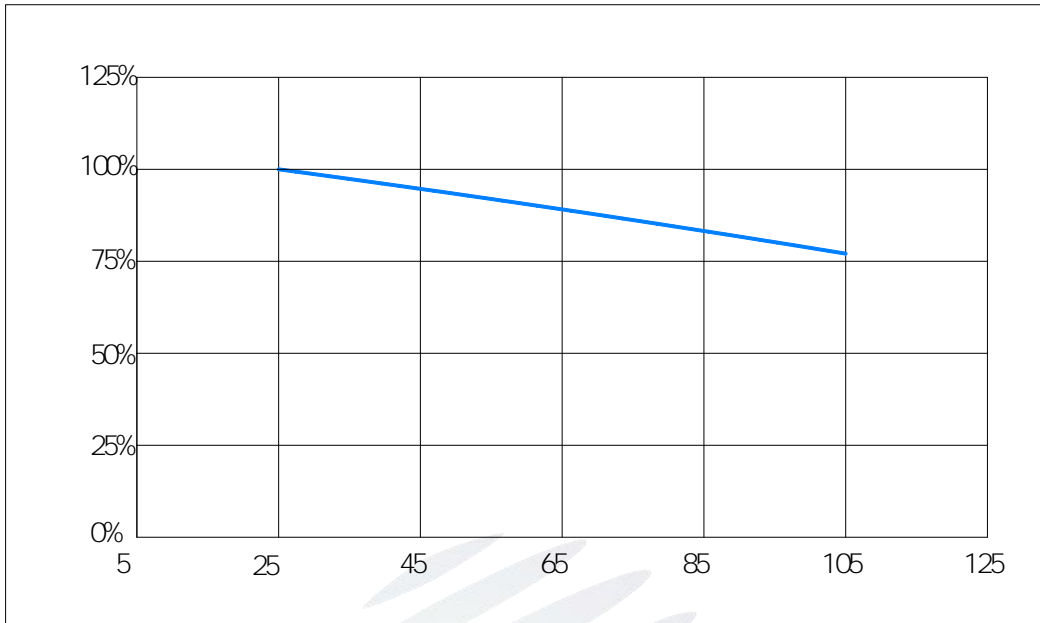



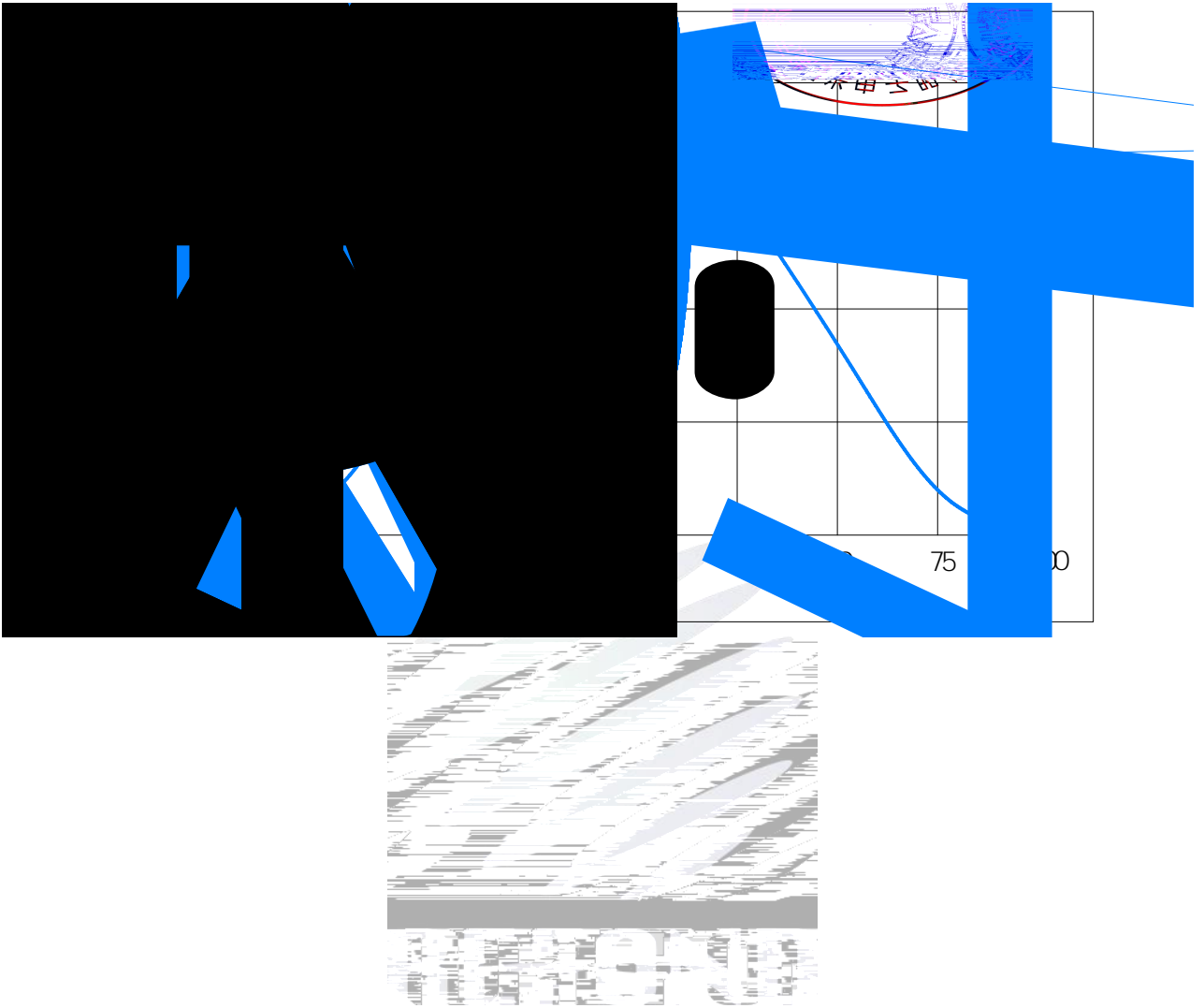

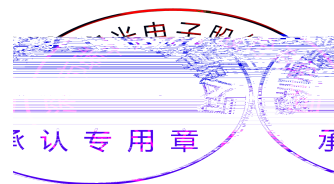
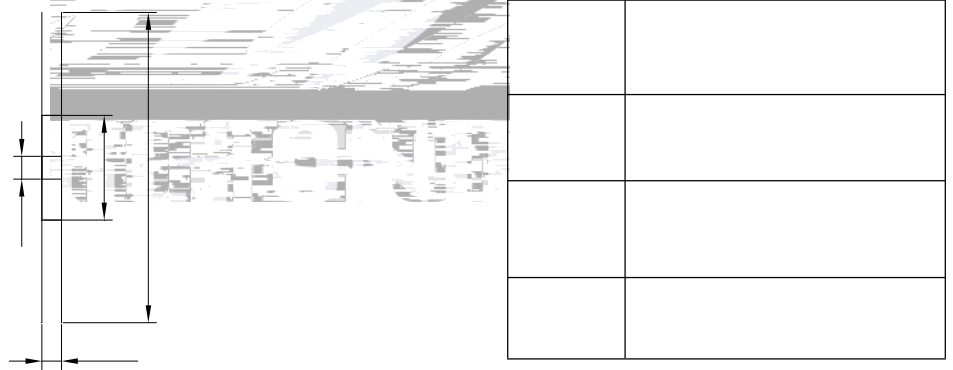
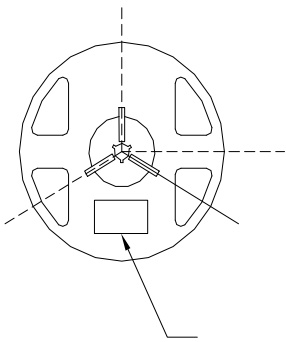
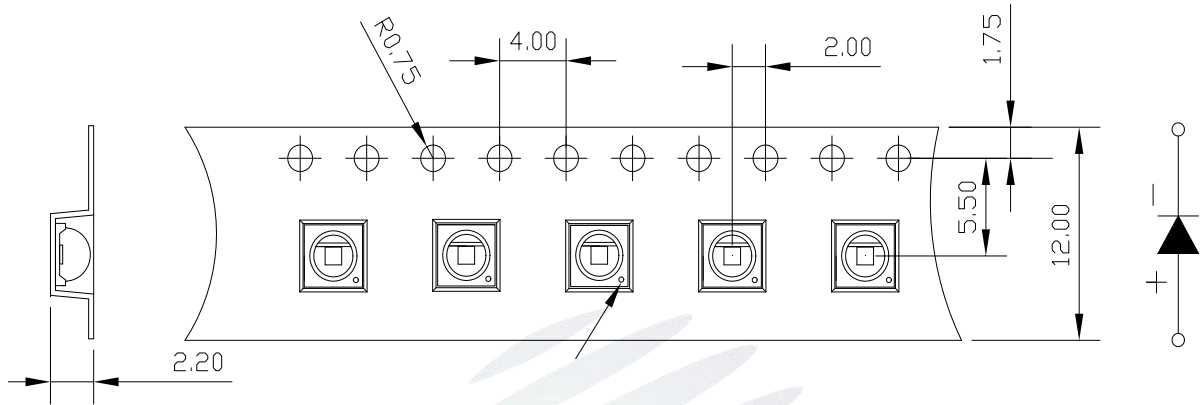

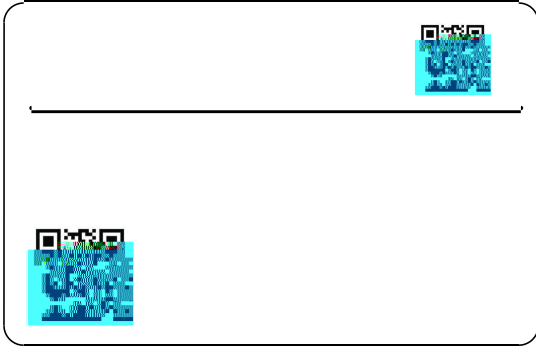

---

---

---

---

---

---

---

---

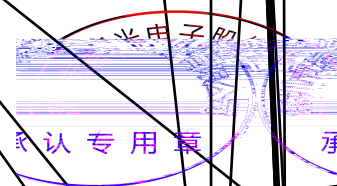
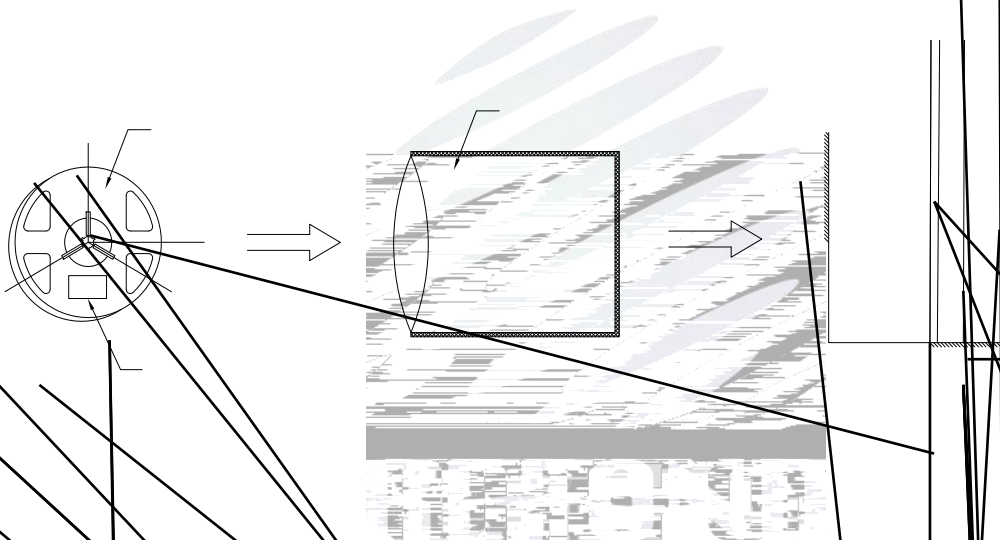

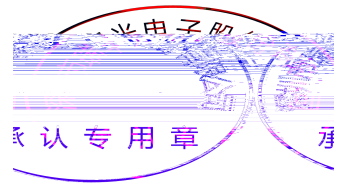
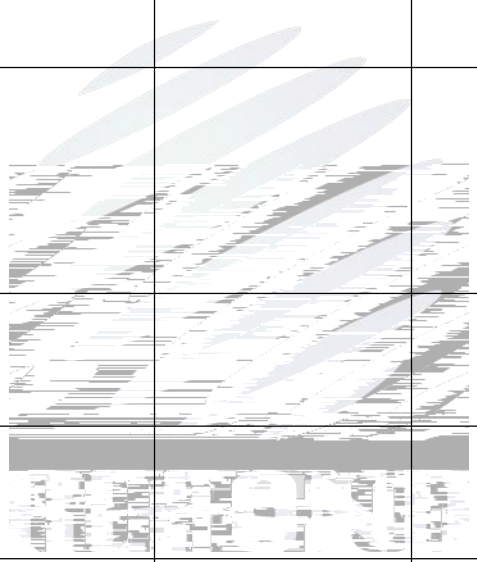



1.

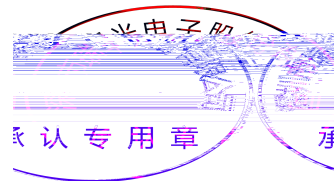

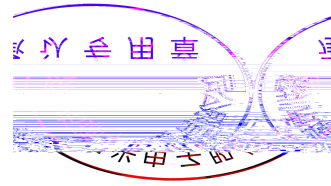

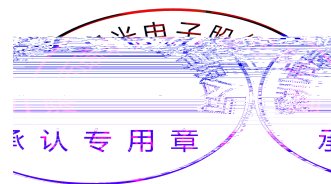
°C

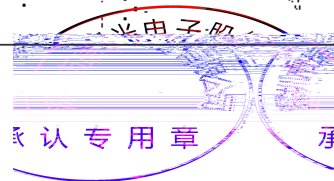
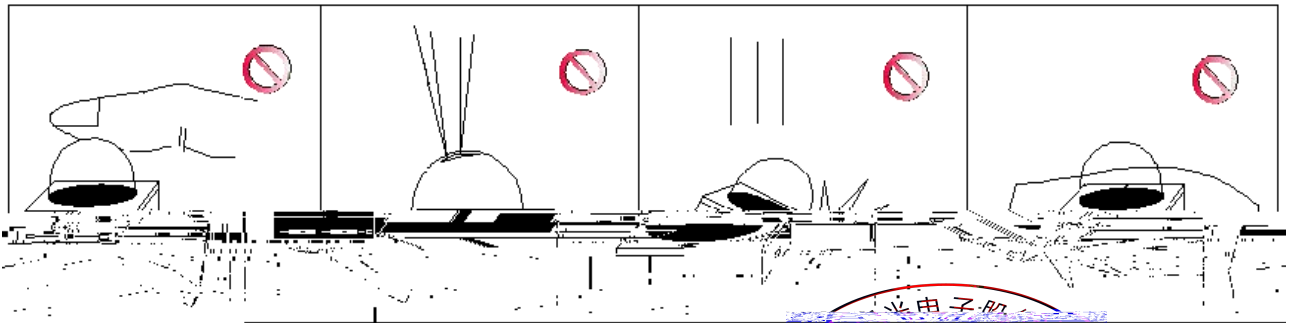





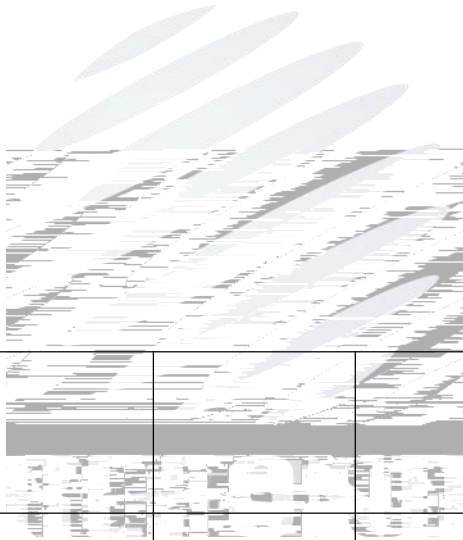

		士	

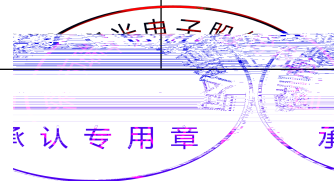

(7)

( )

( ± ) °C

