

# SPECIFICATION

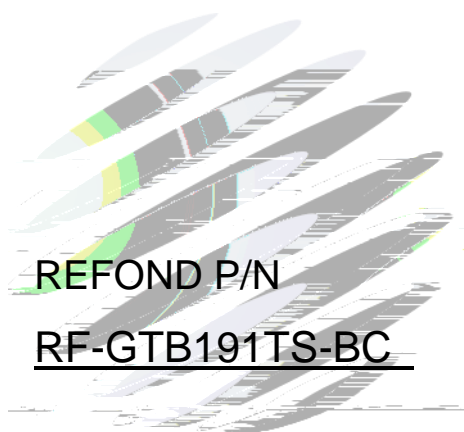

REFOND P/N

RF-GTB191TS-BC



R&D

Mass Product



## Contents

1. Description	3
1.1 General Description	3
1.2 Features	3
1.3 Application	3
1.4 Package Dimension	4
1.5 Product Parameters	5
1.6 Typical Optical Characteristics Curves	8
2. Packaging	12
2.1 Packaging Specification	12
2.1.1 Carrier Tape Dimension	12
2.1.2 Reel Dimension	12
2.1.3 Label Form Specification	13
2.2 Moisture Resistant Packing	13
2.3 Cardboard Box	14
2.4 Reliability Test Items And Conditions	14
2.5 Criteria For Judging Damage	15
3. SMT Reflow Soldering Instructions SMT	16
3.1 SMT Reflow Soldering Instructions SMT	16
4. Handling Precautions	18
4.1 Handling Precautions	18

# 1. Description

## 1.1 General Description



The Colour LED which was fabricated using a green-yellow chip Package Dimension : 1.6mmX0.8mmX0.7mm.

LED

1.6mmX0.8mmX0.7mm

## 1.2 Features

Extremely wide viewing angle.

Suitable for all SMT assembly and solder process.

Moisture sensitivity level: Level 3.

RoHS compliant.

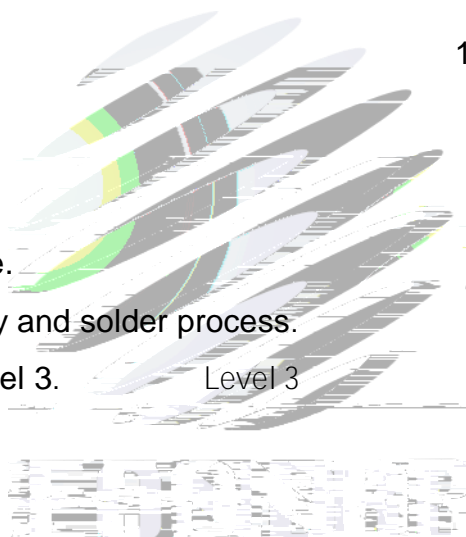

SMT

Level 3

## 1.3 Application

Optical indicator.

Switch and symbol, display.

General use.



### 1.4 Package Dimension

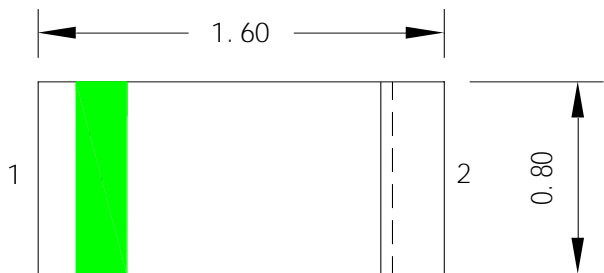

Fig.1-1 Top view

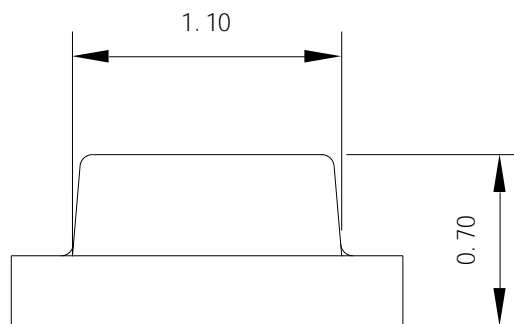

Fig.1-2 Side view

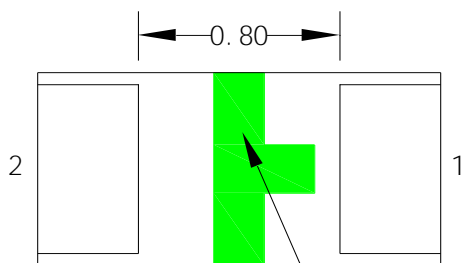

Fig.1-3 Bottom view

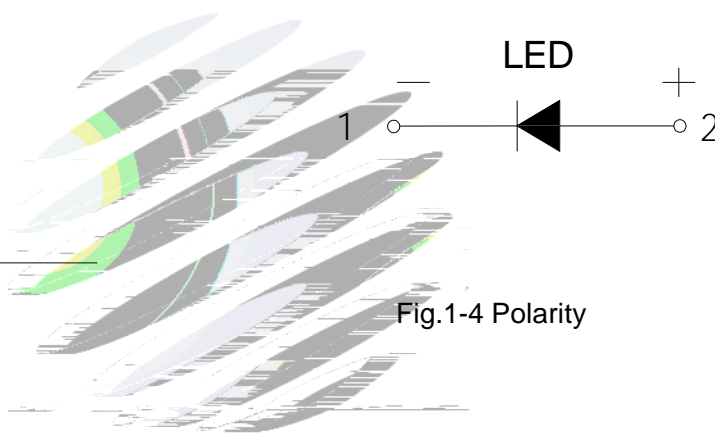

Fig.1-4 Polarity

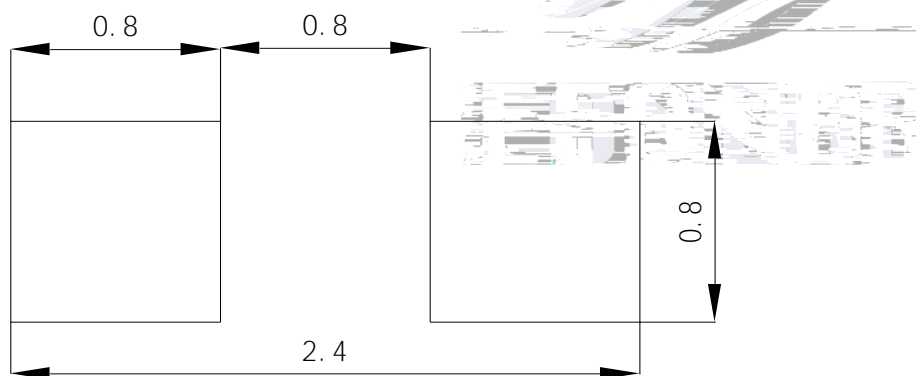

Fig.1-5 Soldering patterns

Notes

1. All dimensions units are millimeters.
2. All dimensions tolerances are 0.2mm unless otherwise noted.



## 1.5 Product Parameters

Table 1-1 Electrical / Optical Characteristics at Ts=25°C

Item Te4 109

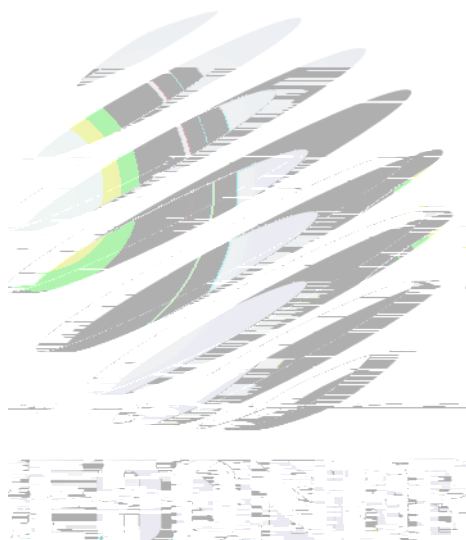

Luminous Intensity	$I_F=20\text{mA}$	$I_v$	1AH	40	--	45	mcd
			1AI	45	--	50	mcd
			1AJ	50	--	55	mcd
			1AK	55	--	60	mcd
			1AL	60	--	65	mcd
			1AM	65	--	70	mcd
			1AN	70	--	75	mcd
			1AO	75	--	80	mcd
			1ED	80	--	85	mcd
			1EE	85	--	90	mcd
			1EF	90	--	95	mcd
			1EG	95	--	100	mcd
Viewing Angle	$I_F=20\text{mA}$		--	140	--	deg	
Reverse Current	$V_R=5\text{V}$	$I_R$	--	--	10	A	
Thermal Resistance.	$I_F=20\text{mA}$	$R_{THJ-S}$	--	--	450	/W	

Notes :  $V_R=5\text{V}$  For test conditions.  $V_R=5\text{V}$



Table 1-2 Absolute Maximum Ratings at Ts=25°C

Parameter	Symbol	Rating	Units
Power Dissipation	$P_d$	72	mW
Forward Current	$I_F$		

## Notes

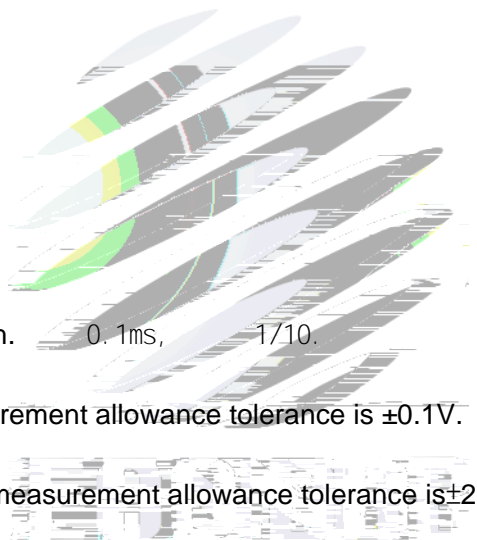
- 
- 1/10 Duty cycle, 0.1ms pulse width. 0.1ms, 1/10.
  - The above forward voltage measurement allowance tolerance is  $\pm 0.1V$ .  $\pm 0.1V$ .
  - The above dominant wavelength measurement allowance tolerance is  $\pm 2nm$ .  $\pm 2nm$ .
  - The above luminous intensity measurement allowance tolerance  $\pm 10\%$ .  $\pm 10\%$ .
  - Care is to be taken that power dissipation does not exceed the absolute maximum rating of the product.
  - All measurements were made under the standardized environment of Refond.
  - When the LEDs are in operation the maximum current should be decided after measuring the package temperature, junction temperature should not exceed the maximum rate. LED

## 1.6 Typical Optical Characteristics Curves

Fig 1-6 Forward Voltage Vs Forward Current

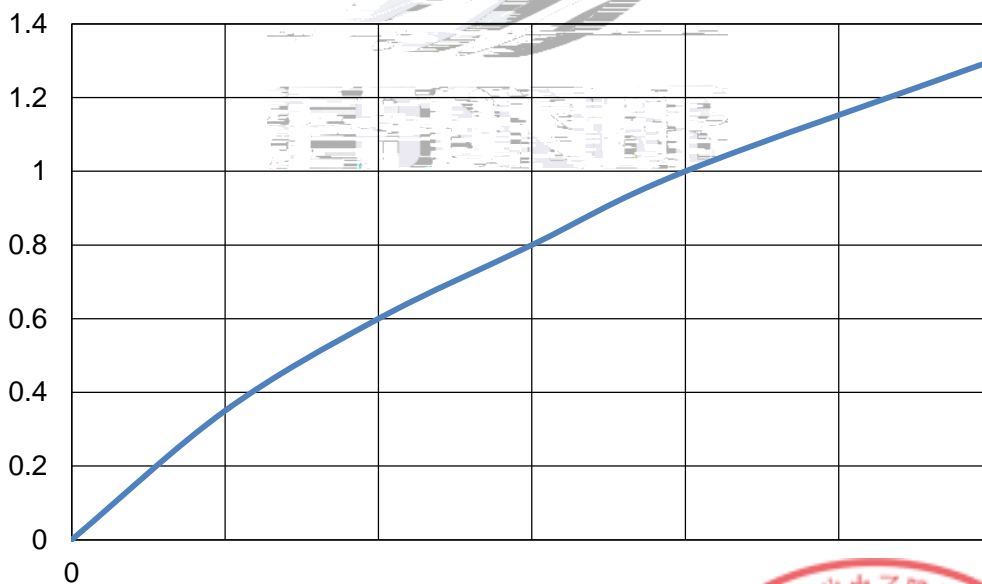

Fig 1-7 Forward Current Vs Relative Intensity





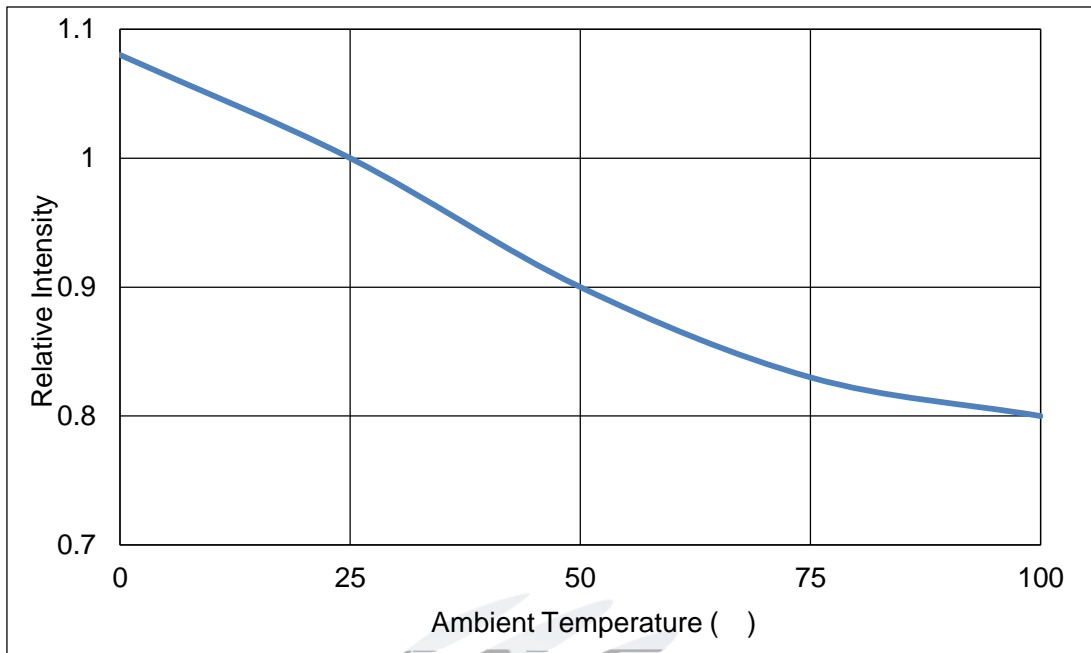

Fig 1-8 Pin Temperature Vs Relative Intensity

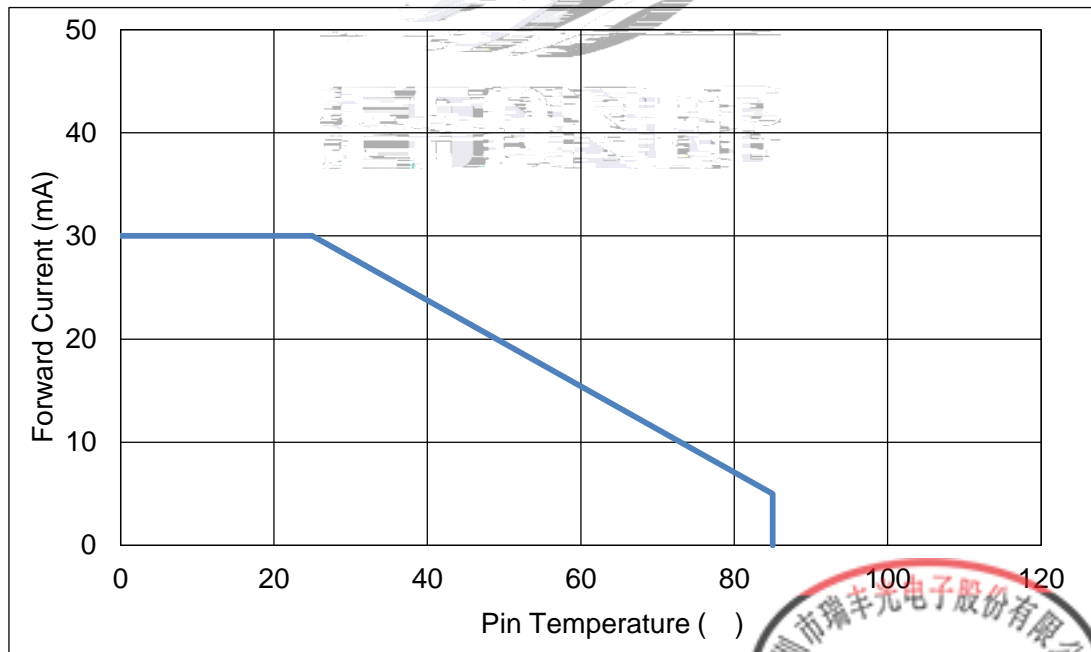
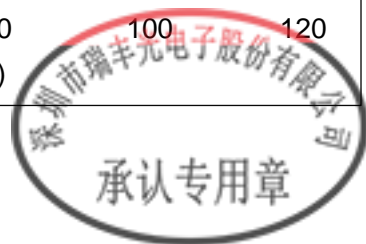

Fig 1-9 Pin Temperature Vs Forward Current



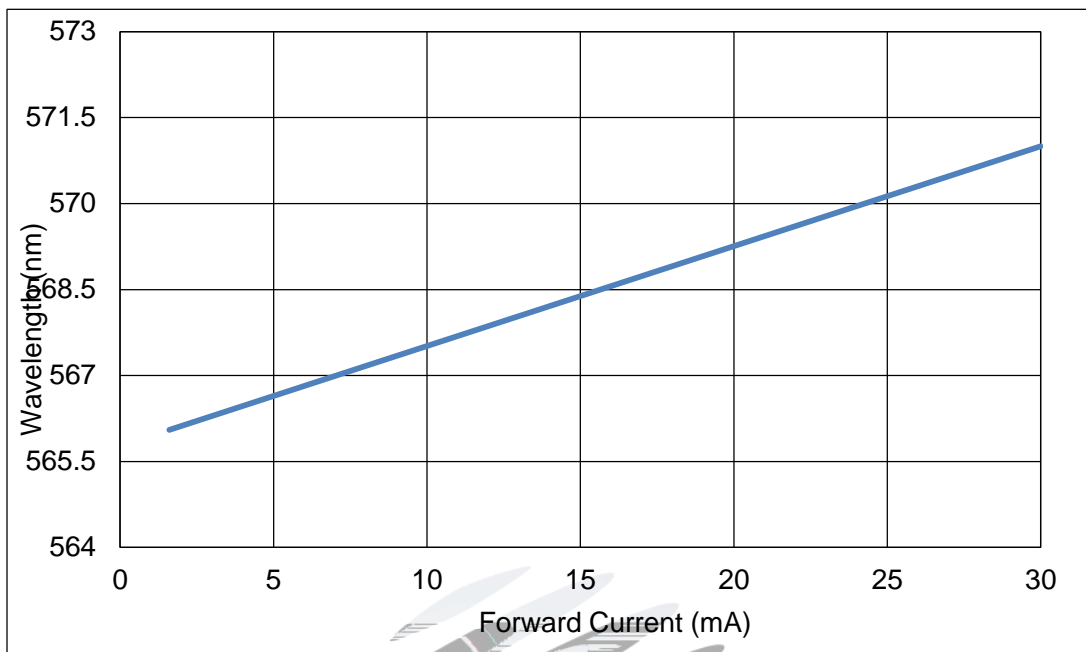

Fig 1-10 Forward Current Vs Dominate Wavelength (Ta=25 °C)

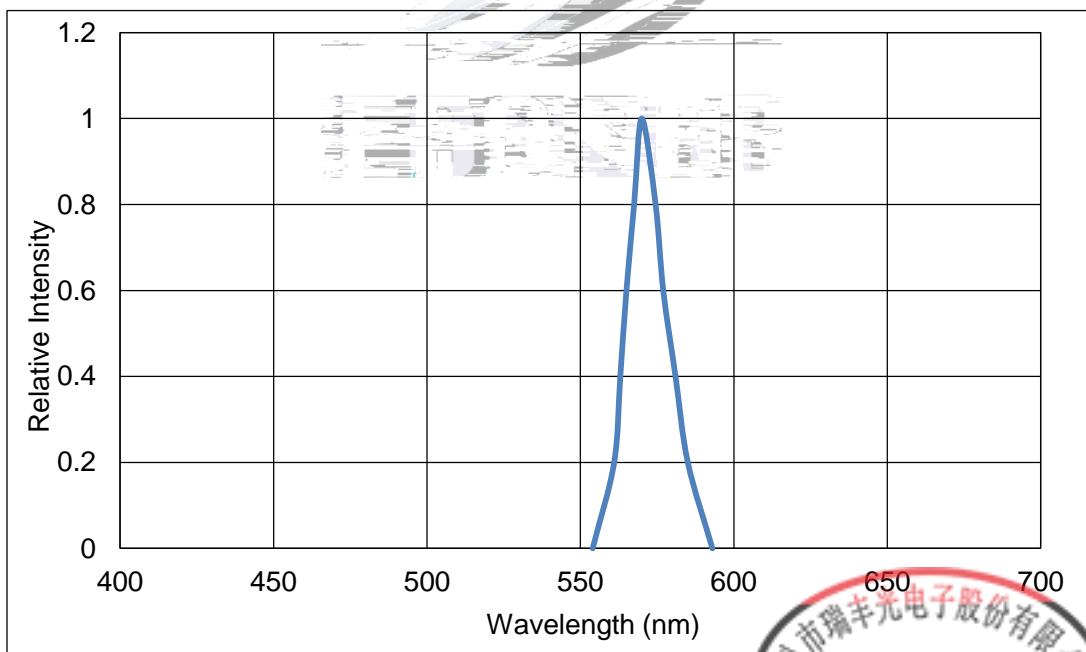
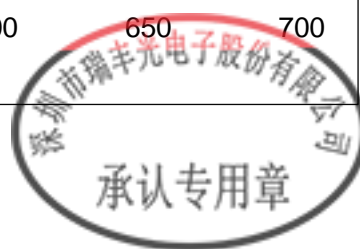

Fig 1-11 Relative Intensity Vs Wavelength (Ta=25 °C)



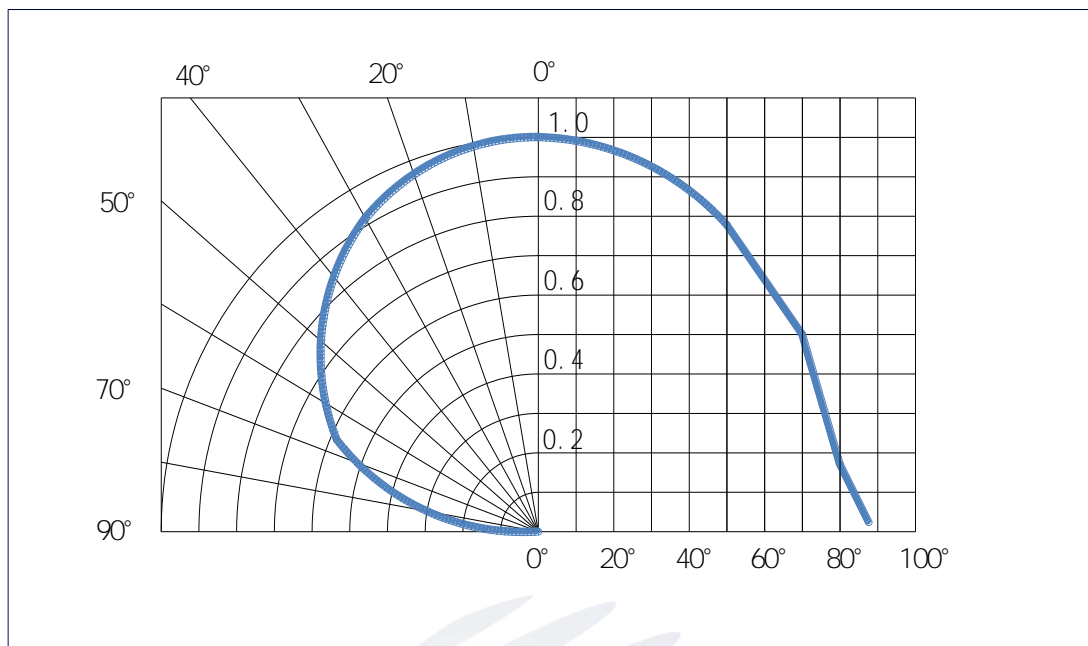
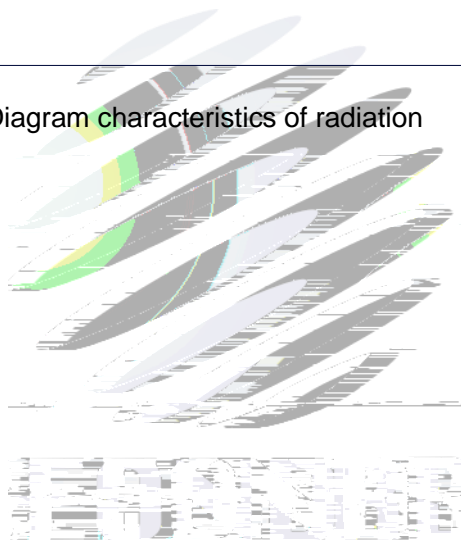

Fig 1-12 Diagram characteristics of radiation



## 2. Packaging

### 2.1 Packaging Specification

Package:4000pcs/reel. 4000pcs

#### 2.1.1 Carrier Tape Dimension

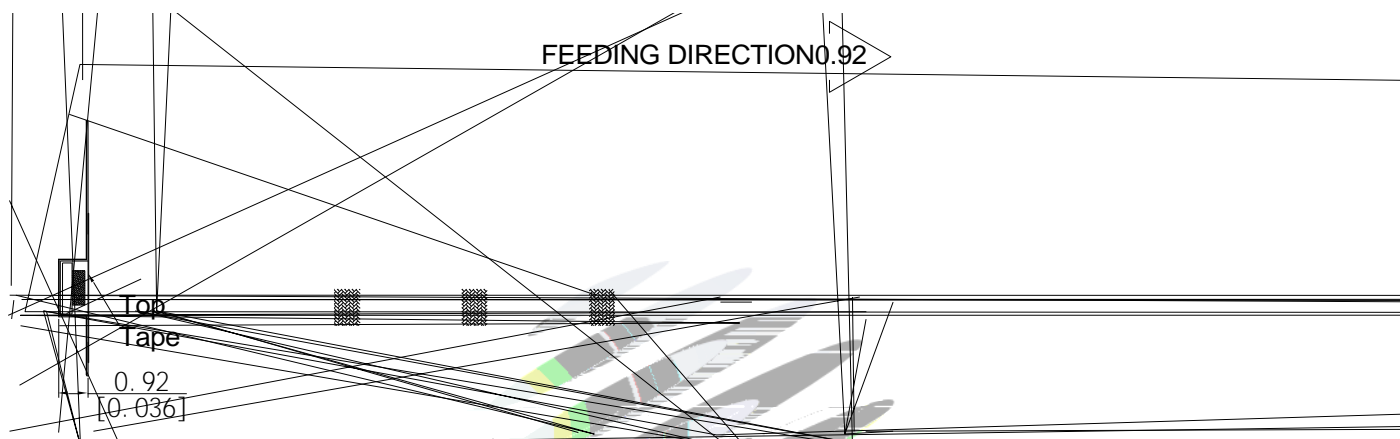

Fig.2-1 Carrier Tape Dimension

#### 2.1.2 Reel Dimension

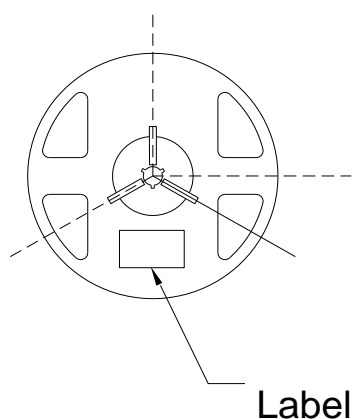

Fig.2-2 Reel Dimension

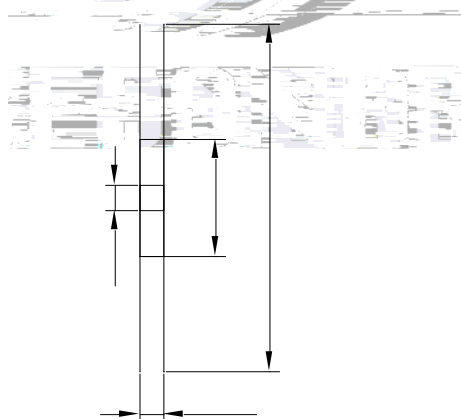

Table 2-1 Dimension

A	8.0± 0.1mm
B	178± 1mm
C	60± 1mm
D	13.0± 0.5mm

#### Notes

The tolerances unless mentioned  $\pm 0.1$ mm. Unit : mm



### 2.1.3 Label Form Specification

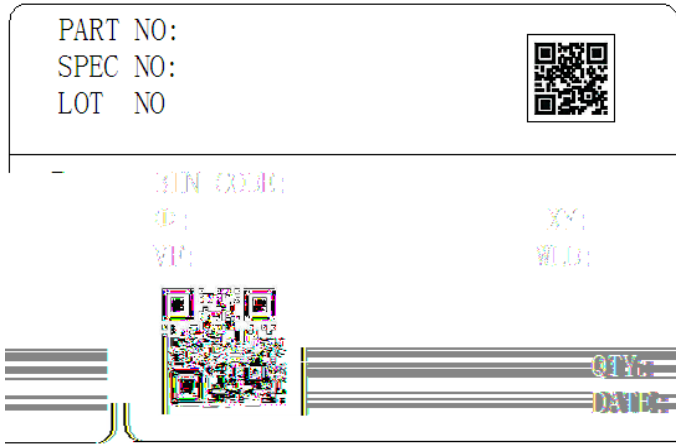

Table 2-2 Parameter

PART NO.	Part Number
SPEC NO.	Spec Number
LOT NO.	Lot Number
BIN CODE	Bin Code
	Luminous flux
XY	Chromaticity Bin
V <sub>F</sub>	Forward Voltage
WLD	Wavelength
QTY	Packing Quantity
DATE	Made Date

Fig. 2-3 Label Form Specification

### 2.2 Moisture Resistant Packing

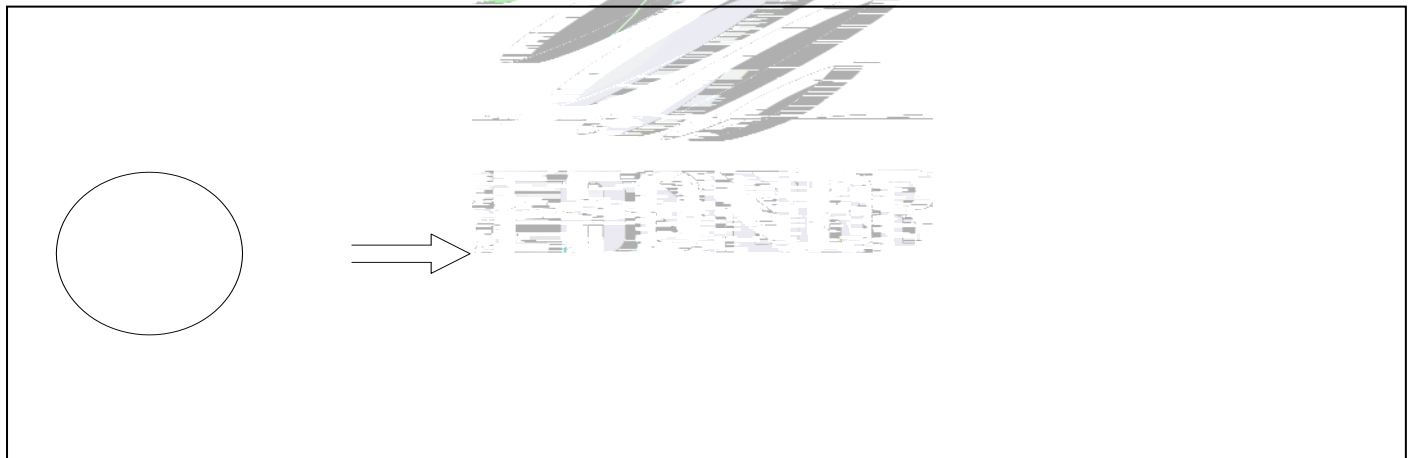

Fig.2-4 Moisture Resistant Packing



## 2.3 Cardboard Box

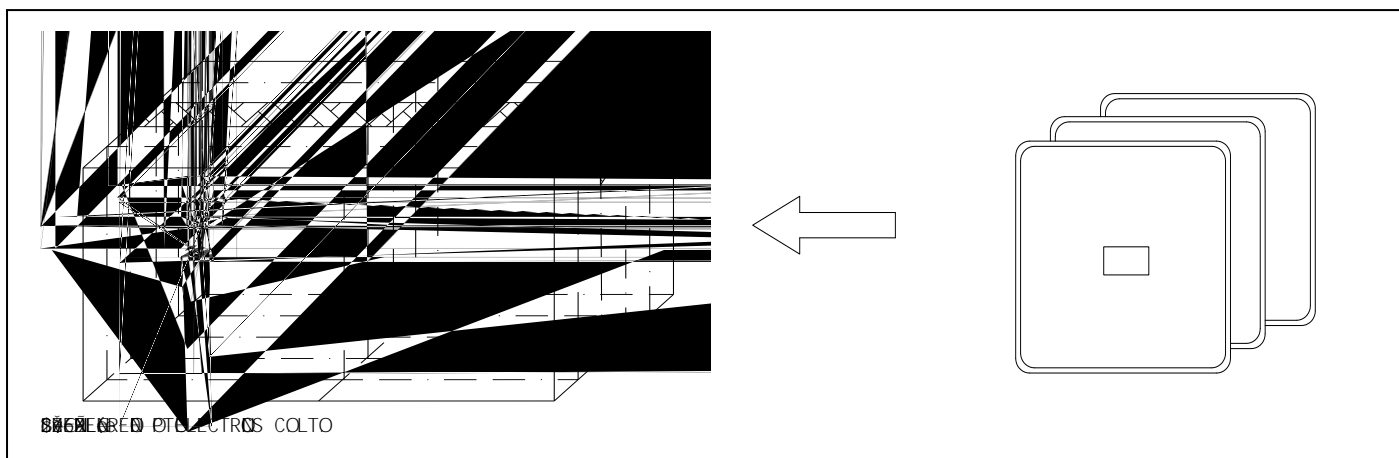
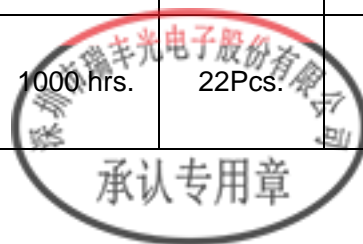

Fig.2-5 Cardboard Box

## 2.4 Reliability Test Items And Conditions

Table 2-3 Reliability Test Items And Conditions

Test Items	Ref.Standard	Test Condition	Time	Quantity	Ac/Re /
Reflow	JESD22-B106	Temp:260 max T=10 sec	2 times	22Pcs.	0/1
Temperature Cycle	JESD22-A104	100 30 min 5 min -40 30 min	100 cycles	22Pcs.	0/1
Thermal Shock	JESD22-A106	-40 15min 100 15min	300 cycles	22Pcs.	0/1
High Temperature Storage	JESD22-A103	Temp:100	1000 hrs.	22Pcs.	0/1
Low Temperature Storage	JESD22-A119	Temp:-40	1000 hrs.	22Pcs.	0/1
Life Test	JESD22-A108	T <sub>a</sub> =25 I <sub>f</sub> =20mA	1000 hrs.	22Pcs.	0/1



## 2.5 Criteria For Judging Damage

Table 2-4 Criteria For Judging Damage

Test Items	Symbol	Test Condition	Criteria For Judgement	
			Min.	Max.
Forward Voltage	$V_F$	$I_F=20\text{mA}$	-	U.S.L*)x1.1
Reverse Current	$I_R$	$V_R= 5\text{V}$	-	U.S.L*)x2.0
Luminous Flux		$I_F=20\text{mA}$	L.S.L*)x0.7	-

### Notes

1.U.S.L: Upper standard level

L.S.L: Lower standard level

2.The above reliability tests is based on the verification of a single/strip LED of Refond's existing experimental platform,the reliability experiment was taken under good heat dissipation conditions. When customers applies the LED to the series and parallel circuit,should take consideration of all the factors such as the

### 3. SMT Reflow Soldering Instructions SMT

#### 3.1 SMT Reflow Soldering Instructions SMT

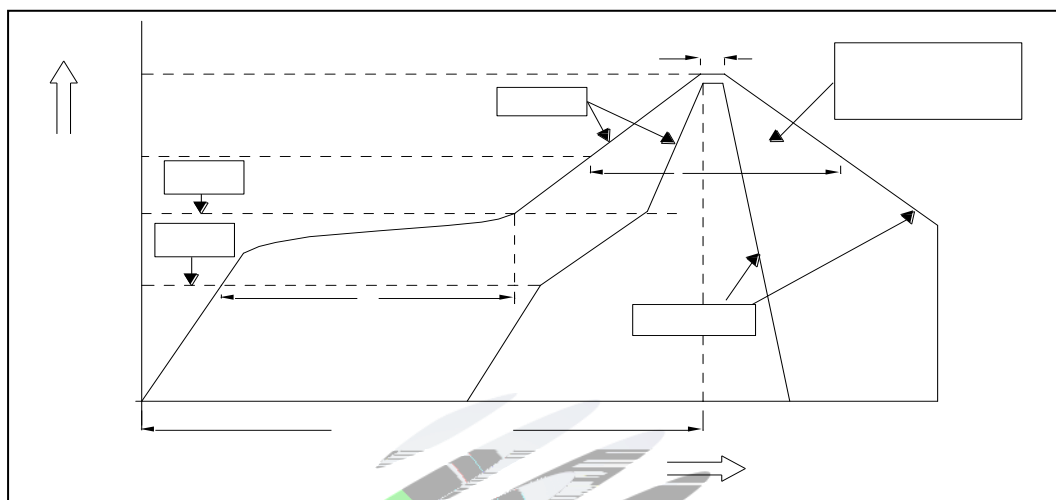
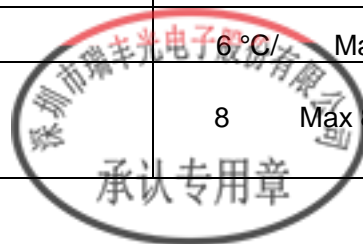

Fig.3-1 SMT Reflow Soldering Instructions SMT

Table 3-1 Parameters

Average temperature rise speed	$T_{smax}$ $T_P$	3 °C/	Max 3 °C/ s
Preheating: minimum temperature	( $T_{smin}$ )	150 °C	
Preheating: Max temperature	( $T_{smax}$ )	200 °C	
Preheating: Time	$T_{smin}$ $T_{smax}$	60 - 120	60s-120s
Time limited to maintain high temperature: the temperature	( $T_L$ )	217 °C	
Time limited to maintain high temperature: The Time	( $t_L$ )	60 - 150	60s-150s
Peak /Classification of temperature:	( $T_P$ )	260 °C	
Time limit classification of peak temperature time	$t_p$	10	Max 10s
( $T_P$ ) 5 °C	Hold time within 5 ° C with the	30	Max 30s
actual peak temperature ( $T_P$ )			
Cooling speed		6 °C/	Max 6 °C/ s
25 °C	Needed time from 25 °C to $T_p$	8	Max 8 minutes





Notes

(1)Reflow soldering should not be done more than twice.If more than 24 hours between the two solderings,LED will be damaged. 24 LED

(2)Whensoldering , do not put stress on the LEDs during heating.

3.1.1 Soldering Iron

(1) When do soldering by hand, keep the temperature of iron below less 300°C less than 3 seconds , 300 3

(2) Soldering by hand should be done only one time.

3.1.2 Repairing

Repairing should not be done after the LEDs have been soldered. When repairing is unavoidable,a double-head soldering iron should be used (as below figure). It should be confirmed in advance whether the characteristics of LEDs will or not be damaged by repairing.

LED

LED

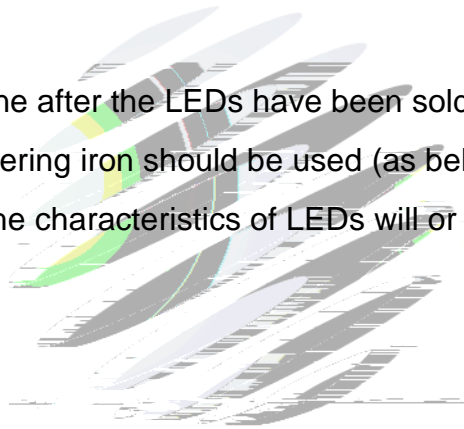

3.1.3 Cautions

The encapsulated material of the LEDs is silicone. Therefore the LEDs have a soft surface on the top of package. The pressure to the top surface will be impacted on the reliability of the LEDs. Precautions should be taken to avoid the strong pressure on the encapsulated part. So when use the picking up nozzle, the pressure on the silicone resin should be proper. LED

LED

(2) Components should not be mounted on warped (non coplanar) portion of PCB. After soldering, do not warp the circuit board.LED PCB

(3) Do not apply mechanical force or excess vibration during the cooling process to normal temperature after soldering. Do not rapidly cool device after soldering.



## 4. Handling Precautions

### 4.1 Handling Precautions

(1) LED operating environment and sulfur element composition cannot be over 100PPM in the LED mating usage material. This is provided for informational purposes only and is not a warranty or endorsement. LED LED 100PPM.

(2) In order to prevent external material from getting into the inside of LED, which may cause the malfunction of LED, the single content of Bromine element is required to be less than 900PPM, the single content of Chlorine element is required to be less than 900PPM, the total content of Bromine element and Chlorine element in the external materials of the application products is required to be less than 1500PPM. This is provided for informational purposes only and is not a warranty or endorsement.

LED LED  
900PPM 900PPM  
1500PPM.

(3) VOCs (Volatile organic compounds) emitted from materials used in the construction of fixtures can penetrate silicone encapsulants of LEDs and discolor when exposed to heat and photonic energy. The result can be a significant loss of light output from the fixture. Knowledge of the properties of the materials selected to be used in the construction of fixtures can help prevent these issues. Refond advises against the use of any chemicals or materials that have been found or are suspected to have an adverse affect on device performance or reliability. To verify compatibility, Refond recommends that all chemicals and materials be tested in the specific application and environment for which they are intended to be used. Attaching LEDs, do not use adhesives that outgas organic vapor. LED

LED

LED

(4) Handle the component along the side surface by using forceps or appropriate tools; Do not directly touch or Handle the silicone lens surface, it may damage the internal circuitry.

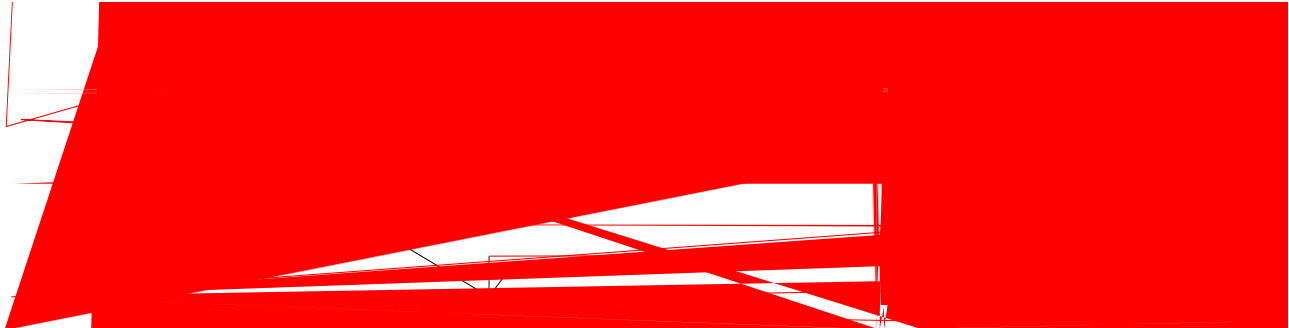
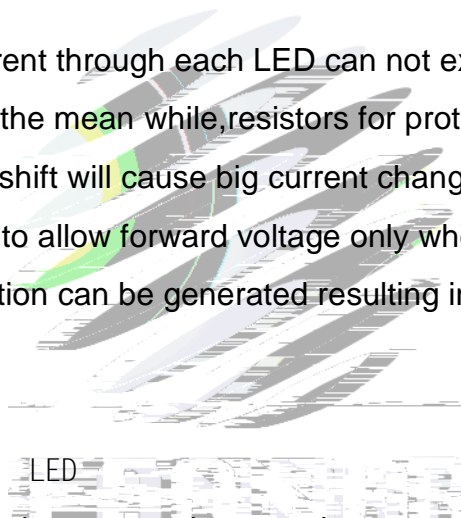

Fig 4-1 Handling Precautions

(5) In designing a circuit, the current through each LED can not exceed the absolute maximum rating specified for each LED. In the mean while, resistors for protection should be applied, otherwise slight voltage shift will cause big current change, burn out may happen. The driving circuit must be designed to allow forward voltage only when it is ON or OFF. If the reverse voltage is applied to LED, migration can be generated resulting in LED damage.

LED



LED

(6) Thermal Design is paramount importance because heat generation may result in the Characteristics decline, such as brightness decreased, Color change and so on. Please consider the heat generation of the LEDs when making the system design. LED

LED

(7) Compared to standard encapsulants, silicone is generally softer, and the surface is more likely to attract dust, requiring special care during processing. In cases where a minimal level of dirt and dust particles cannot be guaranteed, a suitable cleaning solution must be applied to the surface after the soldering of components. Refond suggests using isopropyl alcohol for cleaning. In case other solvents are used, it must be assured that these solvents do not dissolve the package or resin. Ultrasonic cleaning is not recommended. Ultrasonic cleaning may cause damage to the

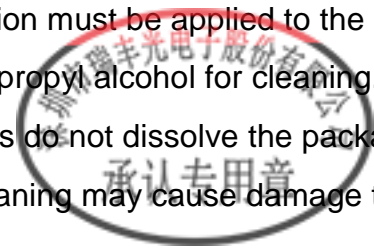

LED.

LED

Table 4-1 Storage

Conditions		Temperature	Humidity	Time
Storage	Before Opening Aluminum Bag	30	75%	Within 1 Year From Date
	After Opening Aluminum Bag	30	60%	168hours 168
Baking		60± 5	-	24hours 24

(8) If the moisture absorbent material silica gel has faded away or the LEDs have exceeded the storage time, baking treatment should be performed after unpacking and based on the following condition 60±5 °C for above 24 hours.

60± 5      24

If the package is flatulence or damaged, please notify the sales staff to assist.

(9) Similar to most Solid state 4P 4001 material

Date	Revisor	Version		Remarks
2019.07.15		E/3		

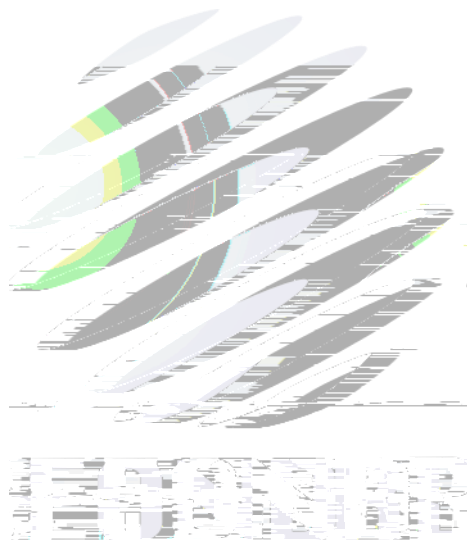



Declare

This specification is written both in English and in Chinese and the latter is formal.