

# SPECIFICATION

## 'a1w“ TT&ü

REFOND P/N 'a1w6 0?

RF-A3H22-W64P-E5

Í 3 % pG0

ÍMass Production;€'a(Ø™

## Contents naE6

1. Description 'a1w•}O	3
1.1 General Description 'a1wL½•£	3
1.2 Features 'a1wfµE,,	3
1.3 Application 'a1wC¾k=	3
1.4 Package Dimension ? '3?o?	4
1.5 Product Parameters 'a1w/iO"	5
1.6 Bin Range Of Forward Voltage and Luminous Flux (IF=1000mA)kO/"&x](PÈ- BIN ... '55 (IF=1000mA)	6
1.7 Typical Optical Characteristics Curves ,)6 +Õ=ÖfµF•R<}A	8
2. Packaging 'a1w.«'3	12
2.1 Packaging Specification .«'3" TT	12
2.1.1 Carrier Tape Dimension œ¿C ?o?	12
2.1.2 Reel Dimension /wn9?o?	12
2.1.3 Label Form Specification SûvŠ" TT	13
2.2 Moisture Resistant Packing "È`Đ.«'3	13
2.3 Cardboard Box .«'3}:vò	13
2.4 Reliability Test Items And Conditions )L™FF•]5— →àna/úRõ'Ý	14
2.5 Criteria For Judging Damage 8ßOj-<>ASû,¥	15
3. SMT Reflow Soldering Instructions SMT	16
3.1 SMT Reflow Soldering Instructions SMT 5 ](cÒ—9PÈ	16
4. Handling Precautions 'a1w(ªk=\\ªH '2-à	18
4.1 Handling Precautions 'a1w(ªk=\\ªH '2-à	18

## 1. Description 'a1w'•}O

### 1.1 General Description 'a1wL½•£

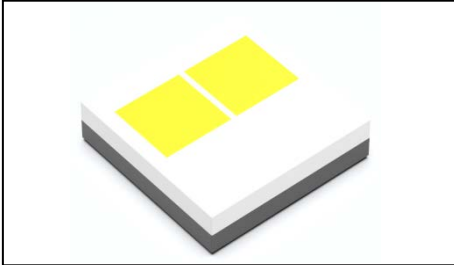

The White LED, which was fabricated by using a blue chip and the phosphor.

Product Package:3.0mmX3.0mmX0.8mm.

—\*'a1w&1m+õ & % {Pýk%°+õ,,ÿfYah0 †f+õxË•\ENÍæ{'a1w?o? ö; N N 9 N N 9 N N o

### 1.2 Features 'a1wfµE,,

Ceramic Package. ©2jØ? '3

Extremely wide viewing angle.0 +õ“-CP8Đ

Suitable for all SMT assembly and solder process. •Ók='5J>Rcm, 4 . ƒ'31\$còLyB",œ

Available on tape and reel. •Ók='5œ¿C /ú/wœ¶

Moisture sensitivity level: Level 2. "È`Đv }) - F W F M

RoHS compliant. \_Ø™Đ P ) '4[

Qualifications: The product qualification test plan is based on the guidelines of AEC-Q102 Stress Test Qualification for Automotive Grade Discrete Semiconductors™4TTö;'a1w™4TT]5— -æ-" 6Ç'5 " & \$2 [üœ"}- u(/1? (dC¾. ]5— ™4TT,¥--

### 1.3 Application 'a1wC¾k=

Automotive Lighting Exterior.œ"8ªd'PÈ



## 1.5 Product Parameters 'a1w/iO"

Table 1-1 Electrical / Optical Characteristics at Ts=25°C kOF•&x+Ö=ÖfµF•

Item àana	Symbol ux0?	Test Condition ]5— Rõ'Y	Value			Unit /@(Y
			Min. æwRR?-)éæ	Typ. æw,)6 )éæx	Max. æwRR8Ð)éæ	
Forward Voltage æwYû0bkO/"æx	VF	IF=1000mA	5.8	---	7.0	V
Reverse Current æw/ÿ0bkO](æx	IR	VR=10V	---	---	10	µA
Luminous Flux æw+Öž j€æx		IF=1000mA	670	---	1000	lm
Viewing Angle æw0 +Ö" -CÐæx		IF=1000mA	---	120	---	deg
Thermal Resistance. æwçs"Öæx	RTHJ-S	IF=1000mA	---	---	3.65	/W

Table 1-2 Absolute Maximum Ratings at Ts=25°C }\_? RR8Ð)é

Parameteræw/iO"æx	Symbolæwux0?æx	Ratingæw)éæx	Unitsæw/@(Yæ
Power Dissipation æw. •ræx	P <sub>D</sub>	8400	mW
Forward Current æwYû0bkO](æx	I <sub>F</sub>	1200	mA
Peak Forward Current æw@½)ékO](æx	I <sub>FP</sub>	2000	mA
Reverse Voltage æw/ÿ0bkO/"æx	V <sub>R</sub>	10	V
Electrostatic Discharge (HBM)æwâýkOæx	E <sub>SD</sub>	8000	V
Operating Temperature æwN (r^)CÐæx	T <sub>OPR</sub>	-40 ~ +125	°C
Storage Temperature æw=, ^)CÐæx	T <sub>STG</sub>	-40 ~ +125	°C
Junction Temperature æwU^æx	T <sub>J</sub>	150	°C

Notes 8Š\pö;

1. 1/10 Duty cycle, 10ms pulse width. •a>^ N T/Qt\_Zñ
2. The above forward voltage measurement allowance tolerance is  $\pm 0.1V$ . 'Ä&sJ>r kO/"j5i€—4Bμ p 7
3. The above color coordinates measurement allowance tolerance is  $\pm 0.005$ . 'Ä&sJ>r 5ÂSûj5i€—4Bμp
4. The above luminous intensity measurement allowance tolerance  $\pm 10\%$ . &s•£0 +ÖE Cpm,j5— +Ë-ý, Bμ&¹ p
5. Care is to be taken that power dissipation does not exceed the absolute maximum rating of the product. (ªk= . hg&v•J™,,•B" >Am,RR8Ð)é o
6. All measurements were made under the standardized environment of Refond. J>Rc]5— YëPý6Ç'5i°&ah;Rcm, Sû,¥]5— C,05 o
7. When the LEDs are in operation the maximum current should be decided after measuring the package temperature, junction temperature should not exceed the maximum rate - &(ª% =m,RR8ÐkO](ª='³TOL O"çŠRö 'ÝpÁ>Aæ{}U^&v•J™,,•BRR8Ð)é o
8. ESD yield is over 90% at 8000V ESD (HBM). ESD protection during products handing is needed. m, - & % ž •B'f(dW·D- & 4 % 7 ]5— 5^N|(rPž—<\pH áýkO"ËJá o

1.6 Bin Range Of Forward Voltage and Luminous Flux (IF= 1000mA) kO/"&x](PÈ  
- BIN ... '55F=1000mA) 0M

Fig. 1-6 The C.I.E Chromaticity Diagram CIE,€Cb5C

Table 1-4

BIN CODE	CIE-X1	CIE-Y1	CIE-X2	CIE-Y2	CIE-X3	CIE-Y3	CIE-X4	CIE-Y4
6N1	0.3073	0.3043	0.3139	0.3107	0.3110	0.3310	0.3033	0.3234
6N2	0.3139	0.3107	0.3206	0.3171	0.3187	0.3386	0.3110	0.3310
6N3	0.3206	0.3171	0.3272	0.3235	0.3264	0.3462	0.3187	0.3386





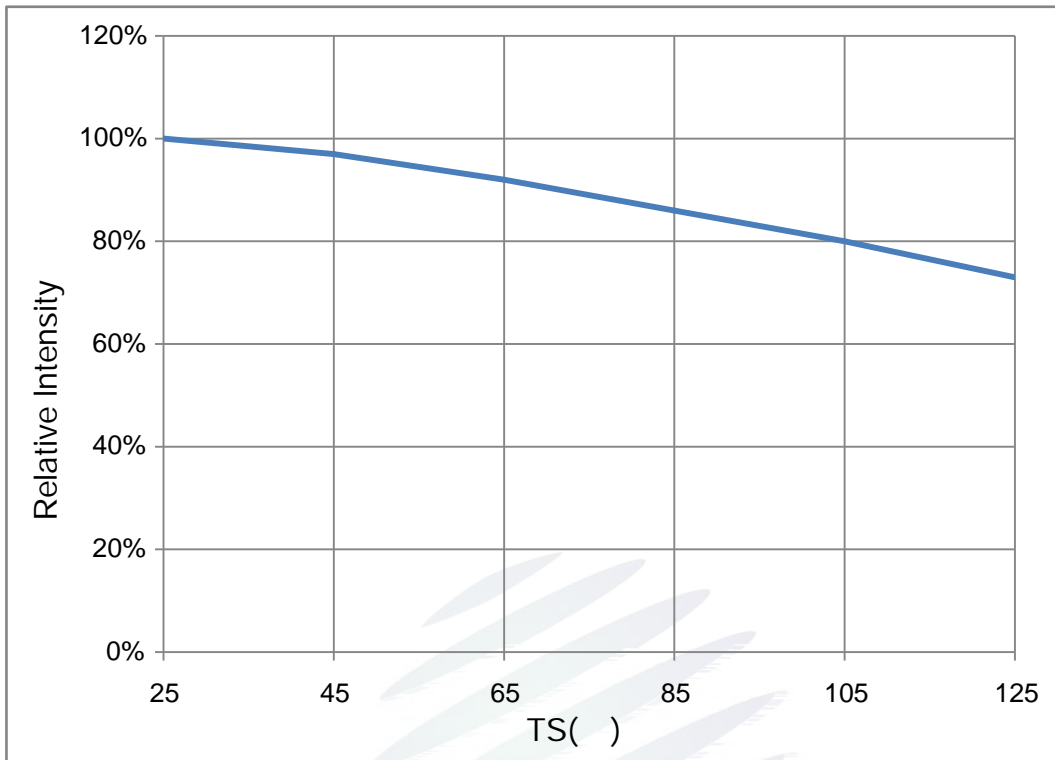

Fig. 1-9 Solder Temperature Vs Relative Intensity

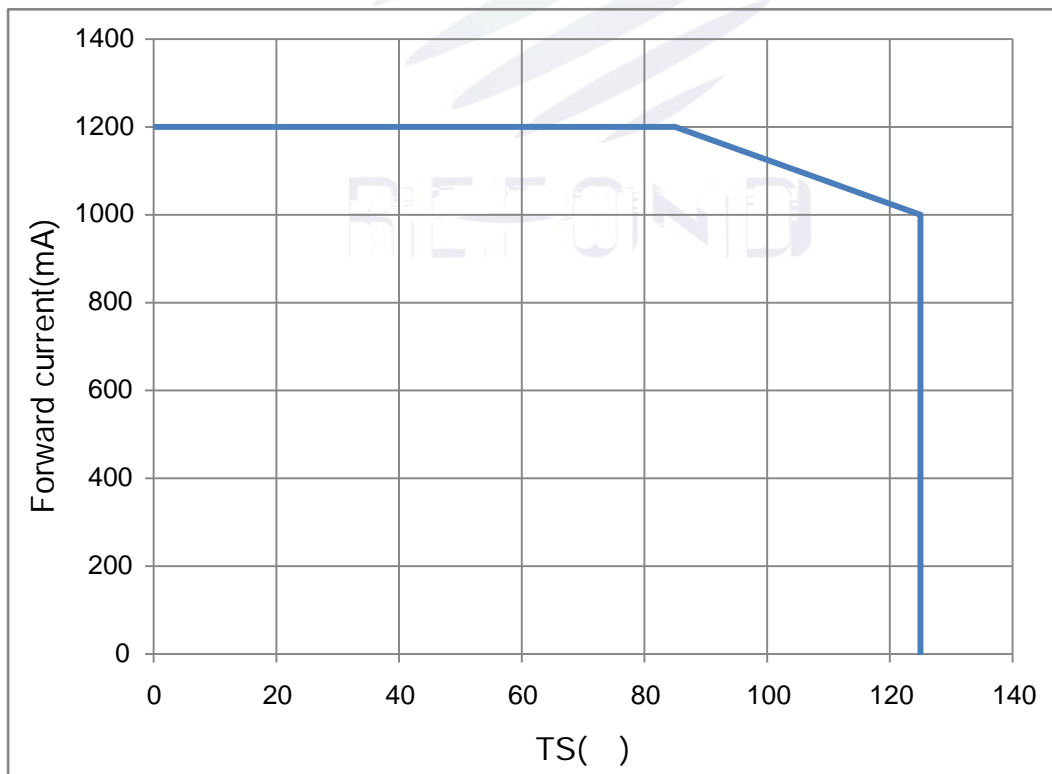

Fig. 1-10 Solder Temperature Vs Forward Current



Fig. 1-13 Chromaticity Coordinate Vs Solder Temperature

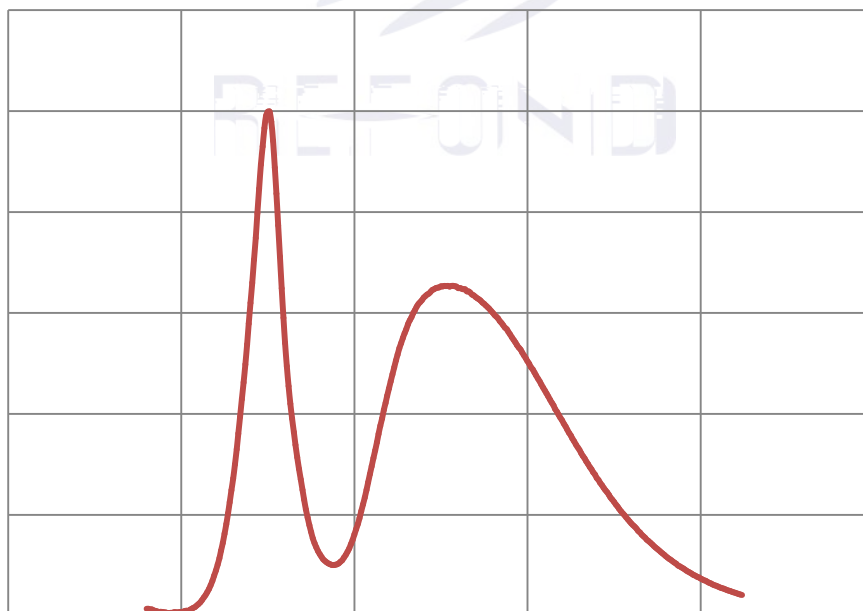

Fig. 1-14 Spectrum Distribution

## 2. Packaging 'a1w.«'3

### 2.1 Packaging Specification .«'3" TT

Package: 4000pcs/reel..«'3Zæ/w4000pcso

#### 2.1.1 Carrier Tape Dimension œ¿C ?o?

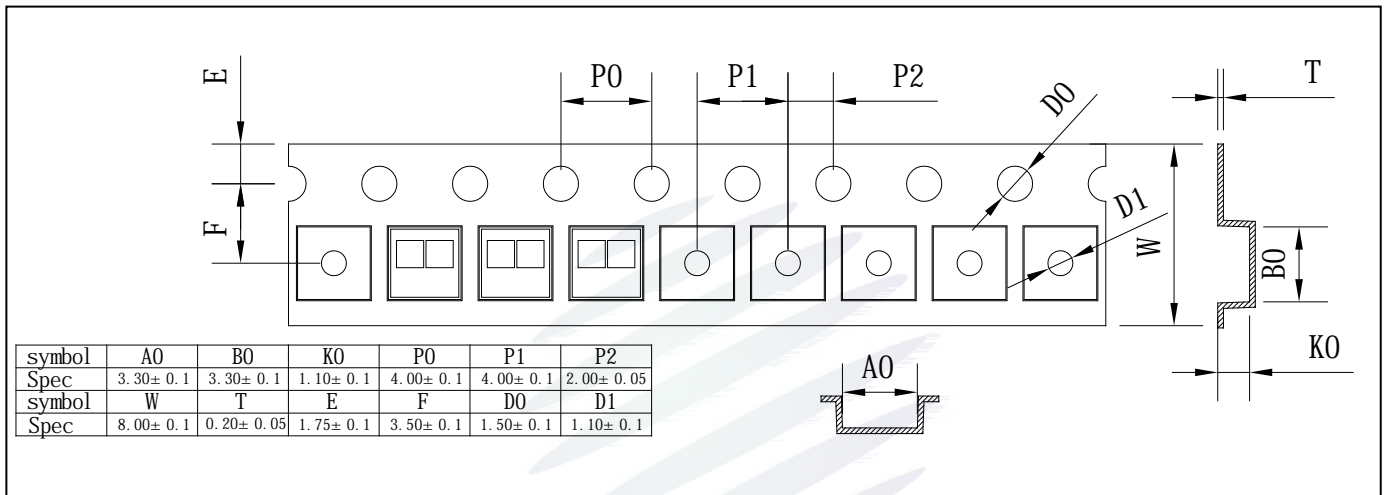

Fig.2-1 Carrier Tape Dimension œ¿C ?o?

#### 2.1.2 Reel Dimension /wn9?o?

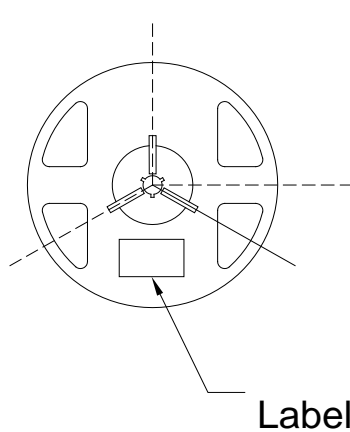

Fig.2-2 Reel Dimension /wn9?o?

#### 5 B C M RReel Dimension /wn9?o?

A	13.6 p0.1mm
B	180 p 1mm
C	100 p 1mm
D	13.0 p0.5mm

Notes 8Š\æö;

The tolerances unless mentioned ±0.1mm. Unit : mm\æö;Rç\æ, Bµ&¹ p [ x'æ{?o? /@ (Yö; [ x' o

### 2.1.3 Label Form Specification SûvŠ“ TT

#### Specification “ TT

PART NO.	Part Number 1w0\
SPEC NO.	Spec Number “ TT
LOT NO.	Lot Number J Yf0?
BIN CODE	Bin Code /iO“¿p&
	Luminous flux +Öž ¿€
XY	Chromaticity Bin „€/
V <sub>F</sub>	Forward Voltage Yû0bkO/“
WLD	Wavelength \\šË'¿p&
QTY	Packing Quantity O“¿€
DATE	Made Date k0'aP`R•

Fig. 2-3 Label Form Specification SûvŠ“ TT

### 2.2 Moisture Resistant Packing “È`Đ. «‘3



Fig.2-4 Moisture Resistant Packing “È`Đ. «‘3

### 2.3 Cardboard Box . «‘3}:vò

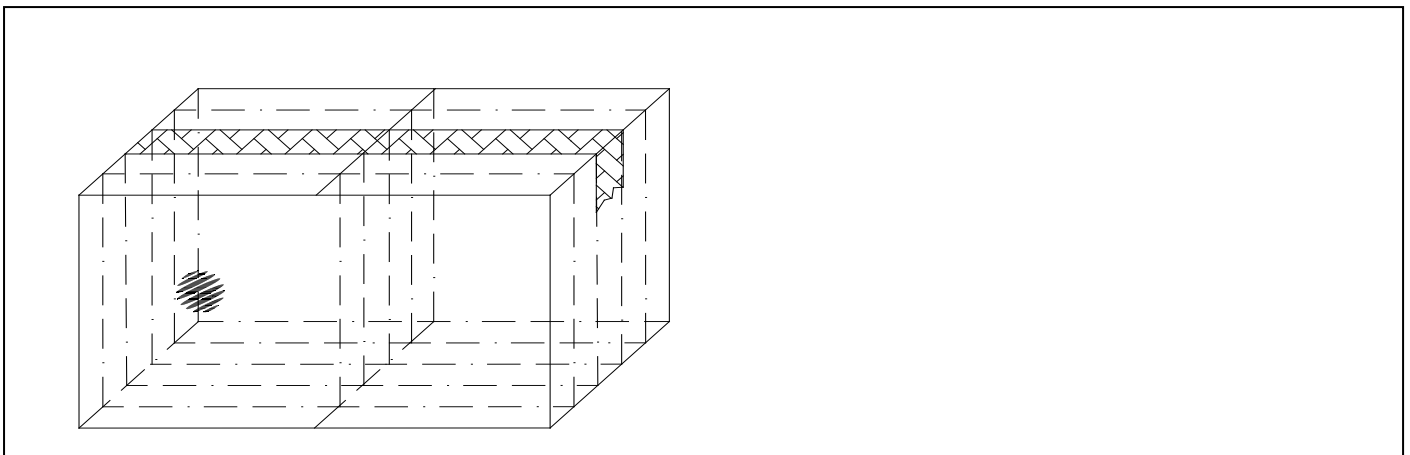

Fig.2-5 Cardboard Box . «‘3}:vò

## 2.4 Reliability Test Items And Conditions )L™FF•]5— -àna/úRõ'Ý

Table 2-3 Reliability Test Items And Conditions )L™FF•]5— -àna/úRõ'Ý

Test Items -àna	Ref.Standard /i•LSû,¥	Test Condition ]5— Rõ'Ý	Time Pž",	Quantity O"i€	Ac/Re LyOPK(OP
Reflow 5 ](cÒ	JESD22-B106	Temp:260 ë max T=10 sec	2times	20pcs.	0/1
MSL2 "È`Đv }2	JESD22-A113	85 ë/ 60%RH	168 hrs.	20pcs.	0/1
Thermal Shock ,†čš,~	JEITAED-4701 300307	-40 ë 15min 10s 125 ë 15min	1000 cycle	20pcs.	0/1
Life Test ± ^)5—	JESD22-A108	Ta=125 ë If=1000mA	1000hrs.	20pcs.	0/1
High Temperature High Humidity Life Test ± ^± _*]5—	JESD22-A101	85 ë/ 85%RH If=1000mA	1000hrs.	20pcs.	0/1

## 2.5 Criteria For Judging Damage 8βOj-<>ASû,¥

Table 2-4 Criteria For Judging Damage 8βOj-<>ASû,¥

Test Items -àna	Symbol ux0?	Test Condition ]5— Rõ'Ý	Criteria For Judgement -<>ASû,¥	
			Min. RR?-	Max. RR8Đ
Forward Voltage Yû0bkO/“	$V_F$	$I_F=1000mA$	-	U.S.L*)x1.1
Reverse Current /ÿ0bkO](	$I_R$	$V_R = 10V$	-	U.S.L*)x2.0
Luminous Flux +Õž i€		$I_F=1000mA$	L.S.L*)x0.7	-

Notes 8Š\pö;

1.U.S.L: Upper standard level “ TT&s“ó L.S.L: Lower standard level “ TT&t“ó

2. The above reliability tests is based on the verification of a single/strip LED of Refond's existing experimental platform, the reliability experiment was taken under good heat dissipation conditions. when customers applies the LED to the series and parallel circuit, should take consideration of all the factors such as the current, voltage distribution, heat dissipation and others. 'Ä&s03« F•]5— Pý6Ç'5i°&ahjRc>J%oC,05/@-ßõ - & %^„{9iO” cšRõ'Ý%o— &tm,)USS o>PJ\*un? & %³k='5&® nC†•ë)Aš Pžæ{ª=fH•d— (.kO]( nkO/“- • nO”cšv “|~ÿ o

3.The technical information shown in the data sheets is limited to the typical characteristics and circuit examples of the referenced products. It does not constitute the warranting of industrial property nor the granting of any license. 'Ä&sJ@R©O“L “&'a1wm,)6 )éæ{0+(r&'i•Læ{&v(r&'ã(fC³k=Rõ'Ý/úC³k=P0D-m,)B— o

### 3. SMT Reflow Soldering Instructions SMT

#### 3.1 SMT Reflow Soldering Instructions SMT 5 [c0—9PÈ

Fig.3-1 SMT Reflow Soldering Instructions SMT 5 [c0—9PÈ

Table 3-1 Reflow parameters

Average temperature rise speed $C, 5^2 / \Delta T_{max} f [T_{max}]$	RR±3 °C/s2 Max 3 °C/ s
Preheating: minimum temperature- $\Delta T_{min}$ ; RR( $\Delta T_{min}$ )	150 °C
Preheating: Max temperature- $\Delta T_{max}$ ; RR± $\Delta T_{max}$	200 °C
Preheating: Time- $\Delta T_{min}$ ; $\Delta T_{min} f [T_{max}]$	60 - 12 ! @ÓS T 2 9ZÍÖ S3!S• q,



Notes 8Š\æö;

(1)Reflow soldering should not be done more than twice. If more than 24 hours between the two solderings , LED will be damaged. 5 ](cÖYfO¨&v03'Ä™,,•B&™Yfæ{&™Yf5 ](cÖm,Pž¨,¨,©l9uSS™,,•B ?-Pžæß•J&K%50¨\_\* •\L 5Á o

(2)Whensoldering , do not put stress on the LEDs during heating.E2cÖLyPžæ{&v'35^RPOñ0 cšPžk=. /¨•8(d••« o

### 3.1.1 Repairing )]•%o

Repairing should not be done after the LEDs have been soldered. When repairing is unavoidable,a double-head soldering iron should be used (as below figure). It should be confirmed in advance whether the characteristics of LEDs will or not be damaged by repairing.

LED5 ](cÖ0\_&vC¾—\*)]8•æ{E2Eó-â)}8•Pžæ{Eó-â(ªk=/'y8âcz§ æ{•\&,'2+ÓC¾pÁ-éYüs+P0D-( &v( L 5ÁR&g% m,fµF• o

### 3.1.2 Cautions \æH '2-à

(1)The encapsulated material of the LEDs is silicone. Therefore the LEDs have a soft surface on the top of package. The pressure to the top surface will be impacted on the reliability of the LEDs. Precautions should be taken to avoid the strong pressure on the encapsulated part. So when use the picking up nozzle, the pressure on the silicone resin should be proper. LED? '3•8&1pŠ•8æ{••« æÁæ±æ{k=. K)/¨•8(d••« ( Eg1ž - & %03« F•æ{5 YüC¾ Rc-ë¨ÈLfP6ÿ +Ý5^K)/¨4<'Ýæ{E2(ªk=0¨3ßPžæ{•8(d••« m,/'¨. C¾PýG E2m, o

(2) Components should not be mounted on warped (non coplanar) portion of PCB. After soldering, do not warp the circuit board.LED bšhß&v'3cÖLy5^DîR<m,1 \$ #S#&sæ{cÖLy&Ó0\_æ{&ò&v'3DîJÓ}Aš S# o

(3) Do not apply mechanical force or excess vibration during the cooling process to normal temperature after soldering. Do not rapidly cool device after soldering.5 ](cÖ&Ó0\_,ž/r•Bs•&¥æ{&v'3? RPOñ>J. 8ª. æ{&ò&v'3RcªN . æ{5 ](cÖ0\_æ{&v'3jwk=ah-ç,ž/rm,P0D- o

## 4. Handling Precautions 'a1w(ak=\#H '2-à

### 4.1 Handling Precautions 'a1w(ak=\#H '2-à

(1) LED operating environment and sulfur element composition cannot be over 100PPM in the LED mating usage material. This is provided for informational purposes only and is not a warranty or endorsement. LED B”(r

h 7/ú&x - & %Ó •m, RPOn&#p»+Ëz /ú.Ê0VfYlí'ç&v03™,,•B 1 1 .•o0+Pý&g&jDŠ-óæ{&v(r'ã(f1w™ K )B o

(2) In order to prevent external material from getting into the inside of LED, which may cause the malfunction of LED, the single content of Bromine element is required to be less than 900PPM, the single content of Chlorine element is required to be less than 900PPM, the total content of Bromine element and Chlorine

element in the external materials of the application products is required to be less than 1500PPM. This is provided for informational purposes only and is not a warranty or endorsement.&'+"ÈYú8akrfY™ •s, - & %ÿË

'Äz#lí - & %ü, L ( æJ>8...h 7/úJ>k=9 'Yv æ{/ @&gm, \_f+Ëz 0žj€³[ ?-'5 1 1 .æ{/ @&g[ ^+Ëz 0žj€³[ ?-'5

1 1 .æ{ \_f+Ëz &x[ ^+Ëz Fª0žj€Eó-â?-'5 1 1 . •o0+Pý&g&jDŠ-óæ{&v(r'ã(f1w™ K )B o

(3) VOCs (Volatile organic compounds) emitted from materials used in the construction of fixtures can penetrate silicone encapsulants of LEDs and discolor when exposed to heat and photonic energy. The result

can be a significant loss of light output from the fixture. Knowledge of the properties of the materials selected to be used in the construction of fixtures can help prevent these issues. Refond advises against the use of any

chemicals or materials that have been found or are suspected to have an adverse effect on device performance or reliability. To verify compatibility, Refond recommends that all chemicals and materials be tested in the

specific application and environment for which they are intended to be used. Attaching LEDs, do not use adhesives that outgas organic vapor. C³k=9 'Y&#m, K!0 F•fY™ ( ^w•ó-L - & %ÿËæ{5^ž kO'ak0+Õ=©/úcšm, Rõ'Y

&tæ{ ( ? f] - & %ü, „æ{•s•ž#lí&šj~+Õ••æ{Lç-x'+R9 'YRPOn•J8çY +Y'ak0•o'H"-y oi°&ª/y? (ak='ã(f? - & %

4<'Ym, F•Jlô•O03« F•Rc>rm, fY™ lôRPOnæ{&v vx•o'HRPOñPýBª)Q— >J'+m, •nPý""FUKßRc>r oiİ? fµ>Am, k=ž 1\$

(ak=h 7-æ{i°&ªDŠ-ó? J>Rcm, fY™ 1\$RPOn•s•dnq>, F•m, ]5— o5^™\$'3& %ž)«æ{&v³(ak=•J'ak0RcR¼K!0 F•[^(d

m, xè)U-k o

(4) Handle the component along the side surface by using forceps or appropriate tools; Do not directly touch or Handle the silicone lens surface, it may damage the internal circuitry.ž •B(ak=•ÓE2m, B", (çRPOn(é« 8è0 æ{&v03

nLlyk=J[lô?:\$Xj,,?©/"•8(d••« æ{> 03•J( L 5Á,;ÿËkOš o

Fig 4-1 Cautions \H '2-à

(5) In designing a circuit, the current through each LED can not exceed the absolute maximum rating specified for each LED. In the meanwhile, resistors for protection should be applied, otherwise slight voltage shift will cause big current change, burn out may happen. The driving circuit must be designed to allow forward voltage only when it is ON or OFF. If the reverse voltage is applied to LED, migration can be generated resulting in LED damage.

(6)

REFOND

Table 4-1 Storage <sup>°C</sup>,

Conditions		Temperature	Humidity	Time
s+x«		^)CP	_*CP	Pž”,
Storage	Before Opening Aluminum Bag K.«-x	ö030 ë	ö075%	Within 1 Year From Date &gCf,;
	After Opening Aluminum Bag K.«0_	ö030 ë	ö060%	Recommended for use within 24 hours 24
Baking cwc•		60 p5 ë	-	ö124hours 8Đ'524?-Pž







www.refond.com

REFOND

Declare KMPÉ

This specification is written both in English and in Chinese and the latter is formal.

'a1w" TT&ü'Ä&¥...%OÖP0D-8i..WRc,~tr'Ä&¥OÖf\R¥&&1,¥