

# SPECIFICATION



## Contents

1. Description	3
1.1 General Description	3
1.2 Features	3
1.3 Application	3
1.4 Package Dimension	4
1.5 Product Parameters	5
1.6 Typical Optical Characteristics Curves	8
2. Packaging	13
2.1 Packaging Specification	13
2.1.1 Carrier Tape Dimension	13
2.1.2 Reel Dimension	13
2.1.3 Label Form Specification	14
2.2 Moisture Resistant Packing	14
2.3 Cardboard Box	15
2.4 Reliability Test Items And Conditions	15
2.5 Criteria For Judging Damage	16
3. SMT Reflow Soldering Instructions SMT	17
3.1 SMT Reflow Soldering Instructions SMT	17
4. Handling Precautions	19
4.1 Handling Precautions	19



# 1. Description

## 1.1 General Description



The Colour LED which was fabricated using blue green and orange chip Package  
Dimension : 3.2mmX1.0mmX1.48mm.

LED  
3.2mmX1.0mmX1.48mm

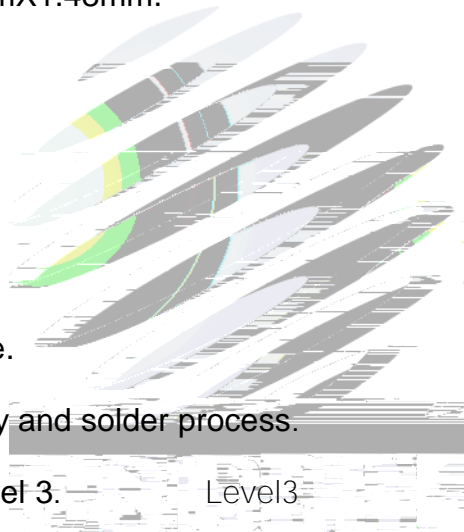

## 1.2 Features

Extremely wide viewing angle.

Suitable for all SMT assembly and solder process. SMT

Moisture sensitivity level: Level 3. Level3

RoHS compliant. RoHS

## 1.3 Application

Optical indicator.

Switch and symbol, display.

General use.



### 1.4 Package Dimension

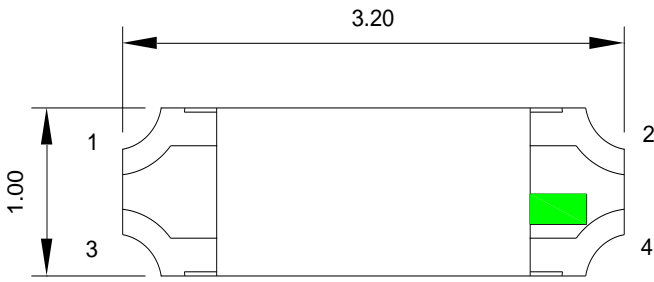

Fig.1-1 Top view

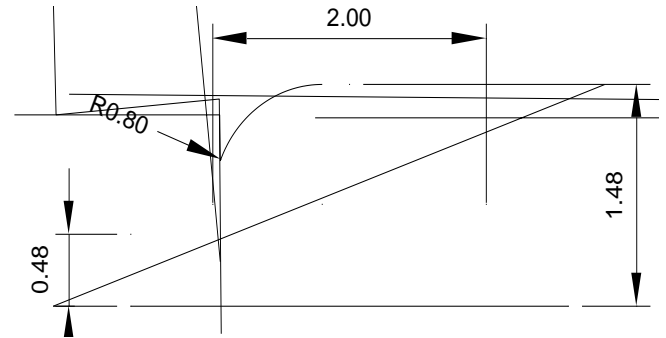

Fig.1-2 Side view

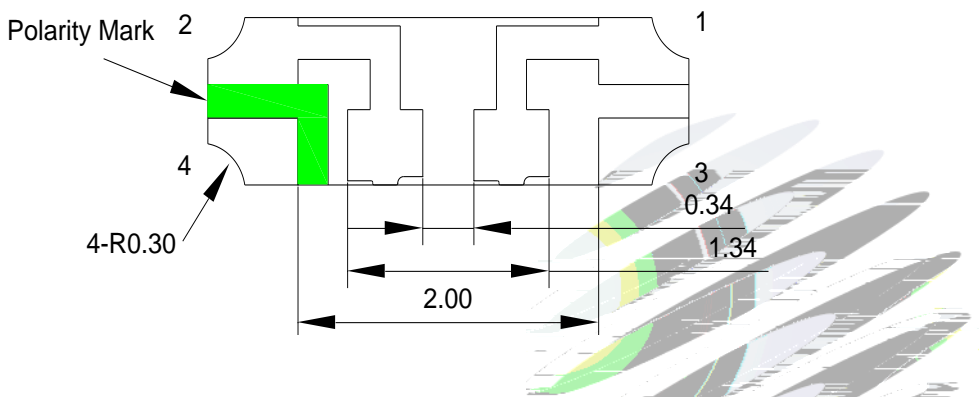

Fig.1-3 Bottom view

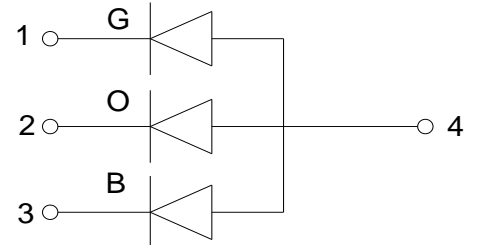

Fig.1-4 Polarity

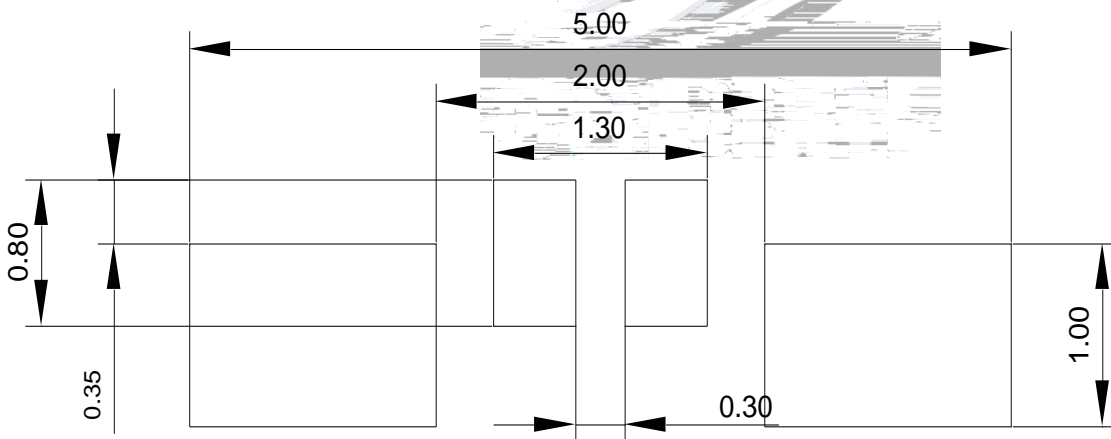

Fig.1-5 Soldering patterns

#### Notes

1. All dimensions units are millimeters.
2. All dimensions tolerances are 0.2mm unless otherwise noted.



t0.2

## 1.5 Product Parameters

Table 1-1 Electrical / Optical Characteristics at Ts=25°C

Item	Test Condition	Symbol		Code	Value			Unit	
					Min. ( )	Typ.	Max.		
Spectral Half Bandwidth	I <sub>F</sub> =20mA	Δ	O	/	--	15	--	nm	
			G		--	30	--		
			B		--	30	--		
Forward Voltage	I <sub>F</sub> =20mA	V <sub>F</sub>	O	1L	1.8	--	2.4	V	
			G	1N	2.8	--	3.5		
			B	1N	2.8	--	3.5		
Dominant wavelength	I <sub>F</sub> =20mA	O		E00	620.0	--	625.0	nm	
				F00	625.0	--	630.0		
				D10	515.0	--	517.5		
				D20	517.5	--	520.0		
				G	E10	520.0	--		522.5
					E20	522.5	--		525.0
		B	d	F10	525	--	527.5	nm	
				F20	527.5	--	530		
			B	D10	465.0	--	467.5		
				D20	467.5	--	470.0		
				E10	470.0	--	472.5		
				E20	472.5	--	475.0		

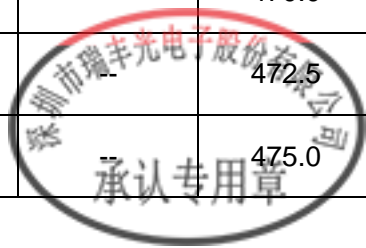



理豐光電

REFOND 理豐光電

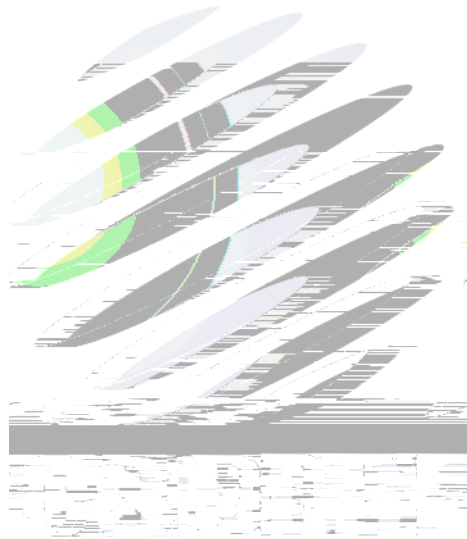

Table 1-2 Absolute Maximum Ratings at Ts=25°C

Parameter	Symbol	Rating			Units
		O	G	B	
Power Dissipation	$P_d$	48	70	70	mW
Forward Current	$I_F$	20			mA
Peak Forward Current Of Pulse	$I_{FP}$	60			mA
Electrostatic Discharge (HBM)	$E_{SD}$	1000			V
Operating Temperature	$T_{opr}$	-40 ~ +85			°C
Storage Temperature	$T_{stg}$	-40 ~ +85			°C
Junction Temperature	$T_j$	95			°C

## Notes

- 1/10 Duty cycle, 0.1ms pulse width. 0.1ms, 1/10.
- The above forward voltage measurement allowance tolerance is  $\pm 0.1V$ . † "\$%l" "
- The above dominant wavelength measurement allowance tolerance is  $\pm 2nm$ . † "&ba" "
- The above luminous intensity measurement allowance tolerance  $\pm 10%$ . † "%\$l" "
- Care is to be taken that power dissipation does not exceed the absolute maximum rating of the product.
- All measurements were made under the standardized environment of Refond.
- When the LEDs are in operation the maximum current should be decided after measuring the package temperature, junction temperature should not exceed the maximum rate. LED



## 1.6 Typical Optical Characteristics Curves

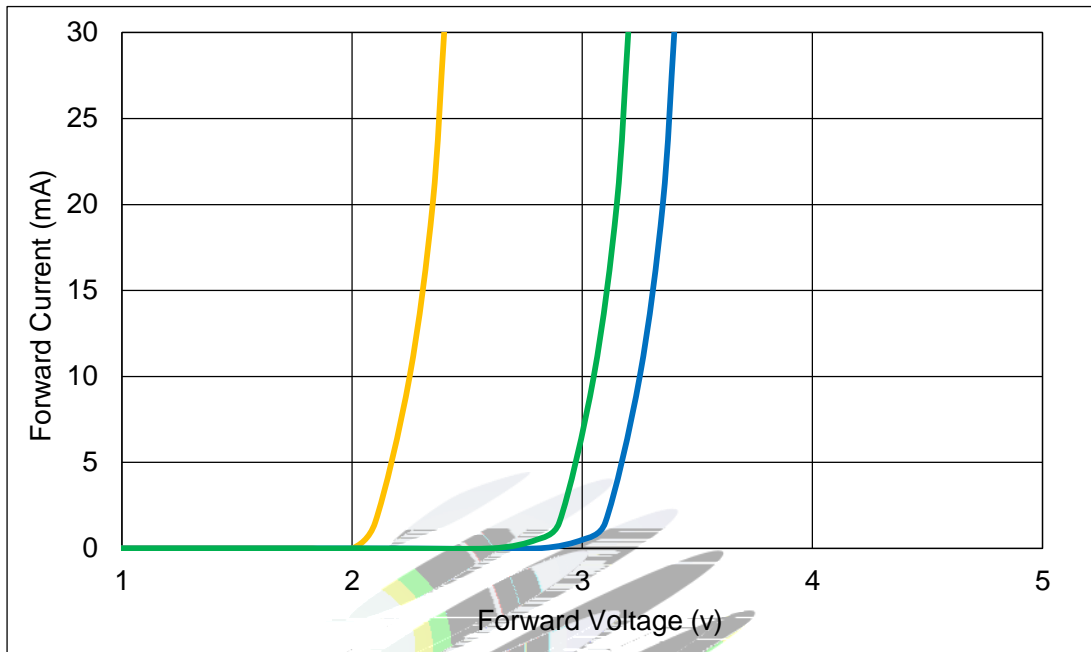

Fig.1-6 Forward Voltage Vs Forward Current

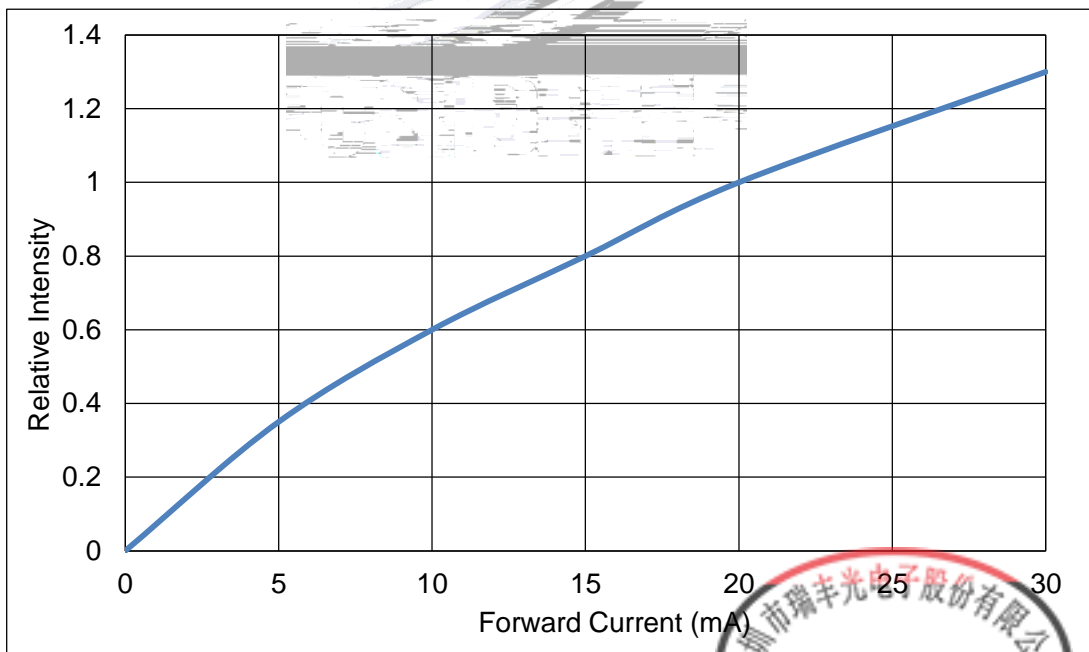
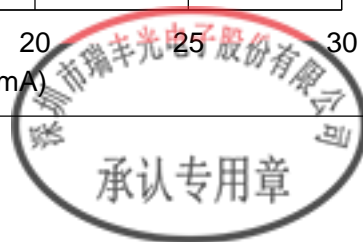

Fig.1-7 Forward Current Vs Relative Intensity





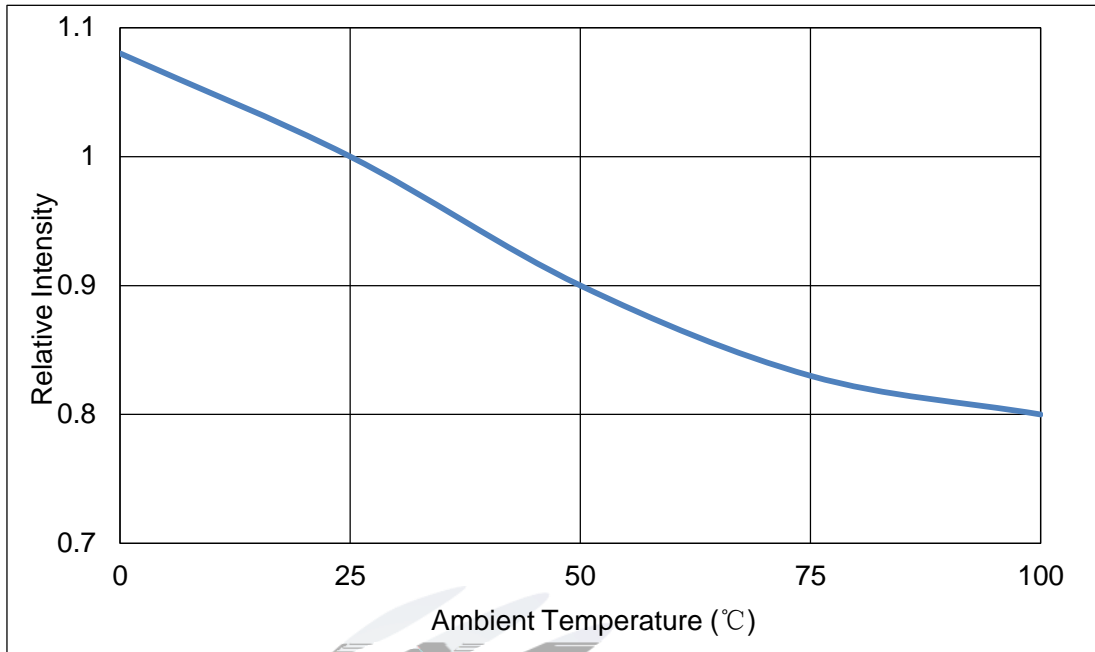

Fig.1-8 Pin Temperature Vs Relative Intensity

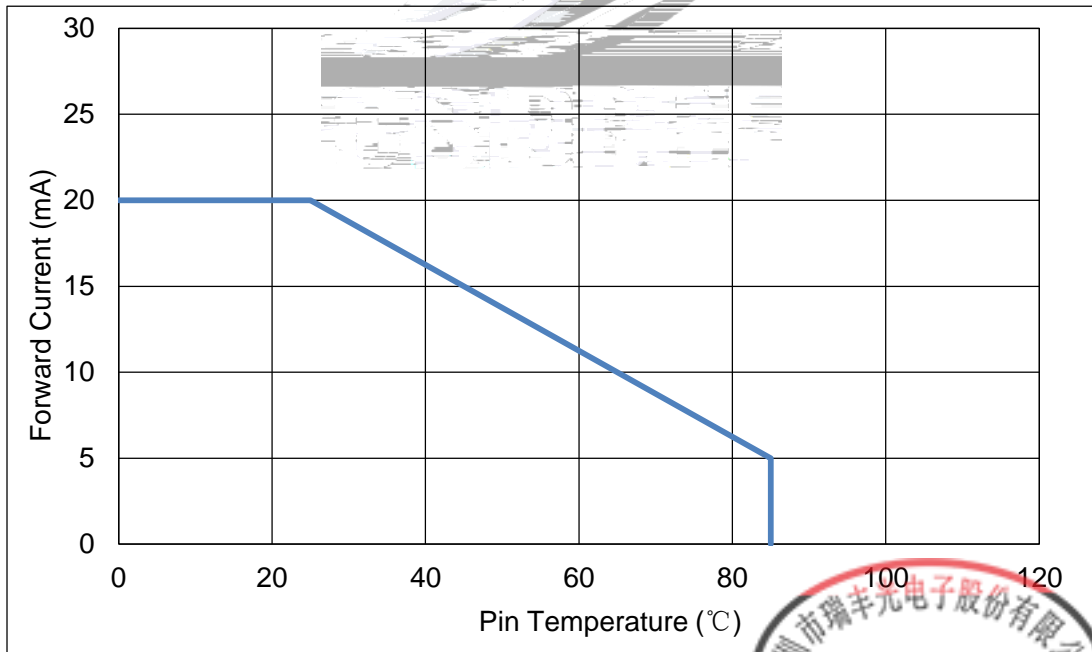

Fig.1-9 Pin Temperature Vs Forward Current



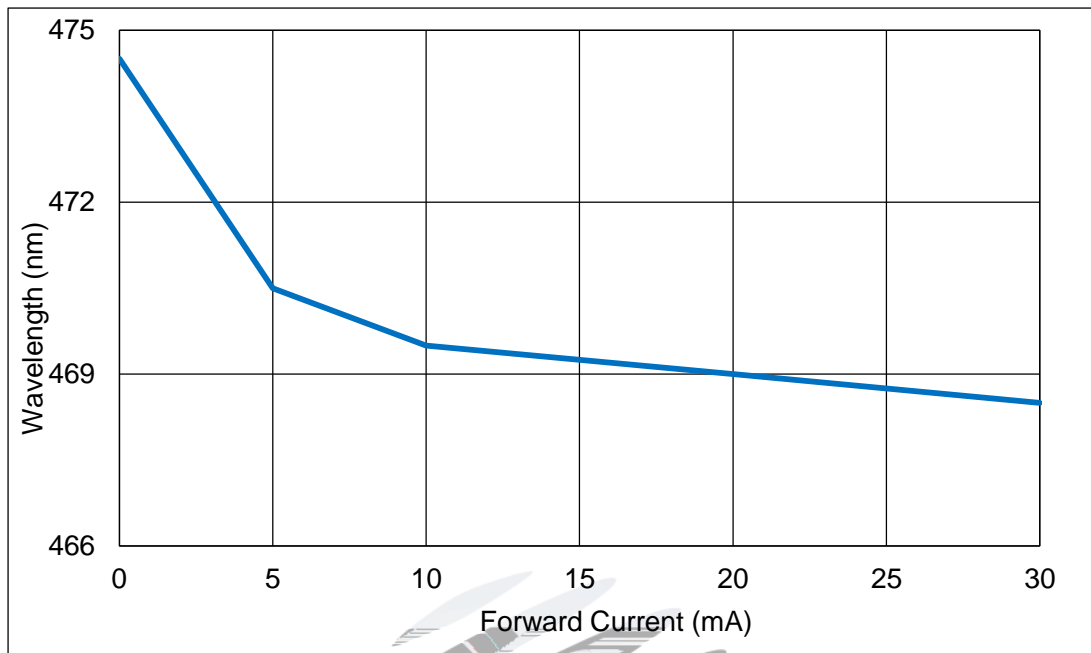

Fig.1-10 Forward Current Vs Dominate Wavelength (Ta=25 )

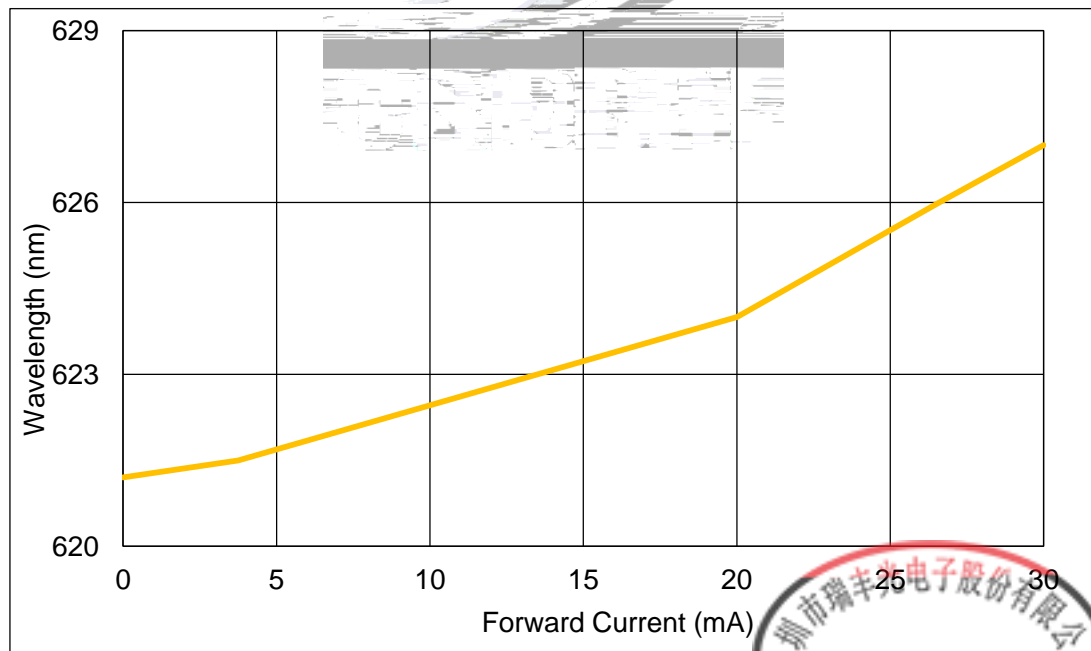
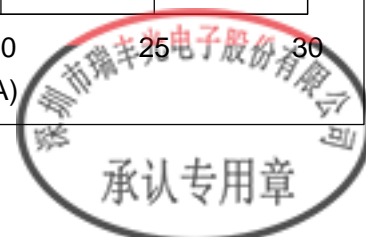

Fig.1-11 Forward Current Vs Dominate Wavelength (Ta=25°C)



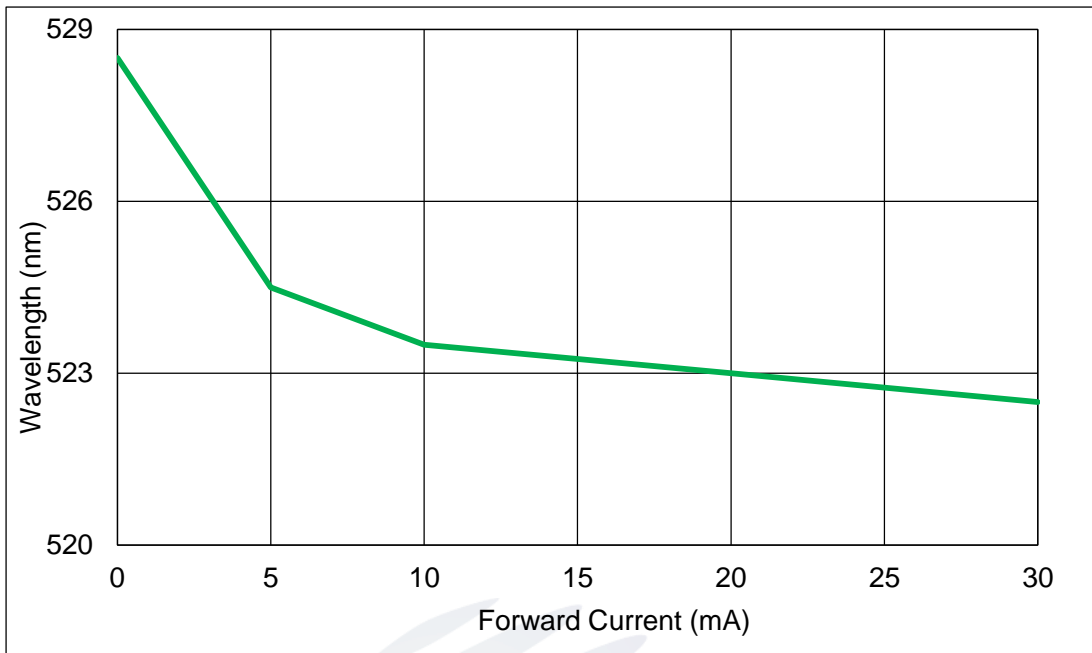

Fig.1-12 Forward Current Vs Dominate Wavelength (Ta=25 )

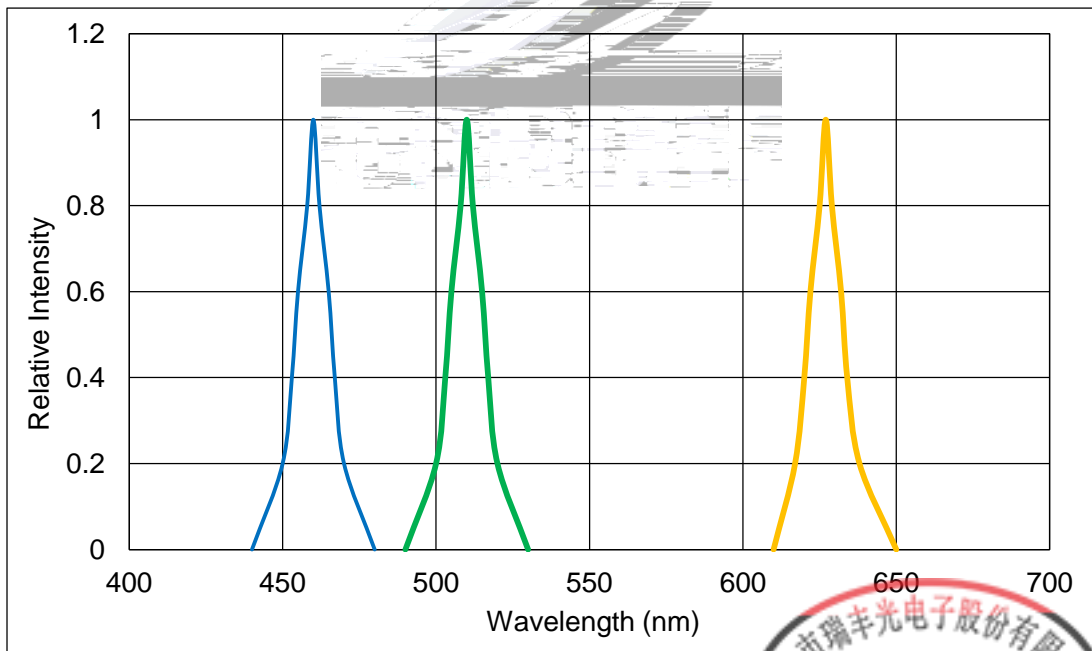

Fig.1-13 Relative Intensity Vs Wavelength (Ta=25°C)



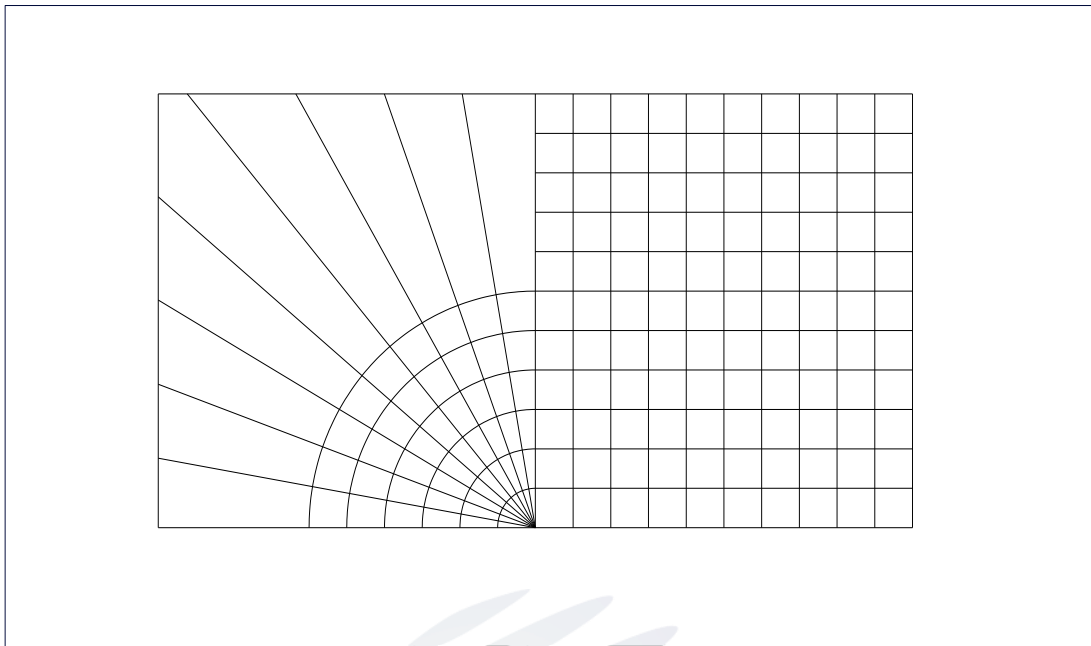
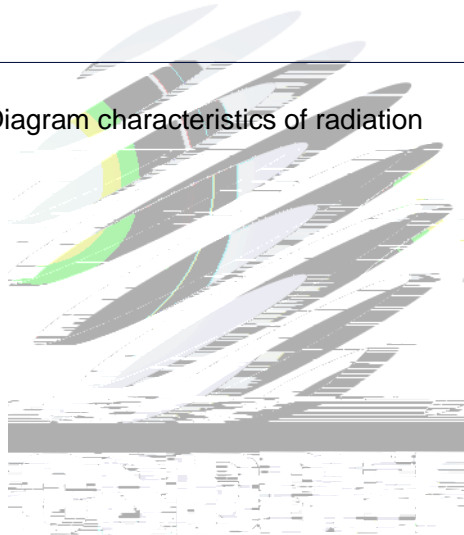

Fig.1-14 Diagram characteristics of radiation



## 2. Packaging

### 2.1 Packaging Specification

Package: 3000pcs/reel. 3000pcs

#### 2.1.1 Carrier Tape Dimension

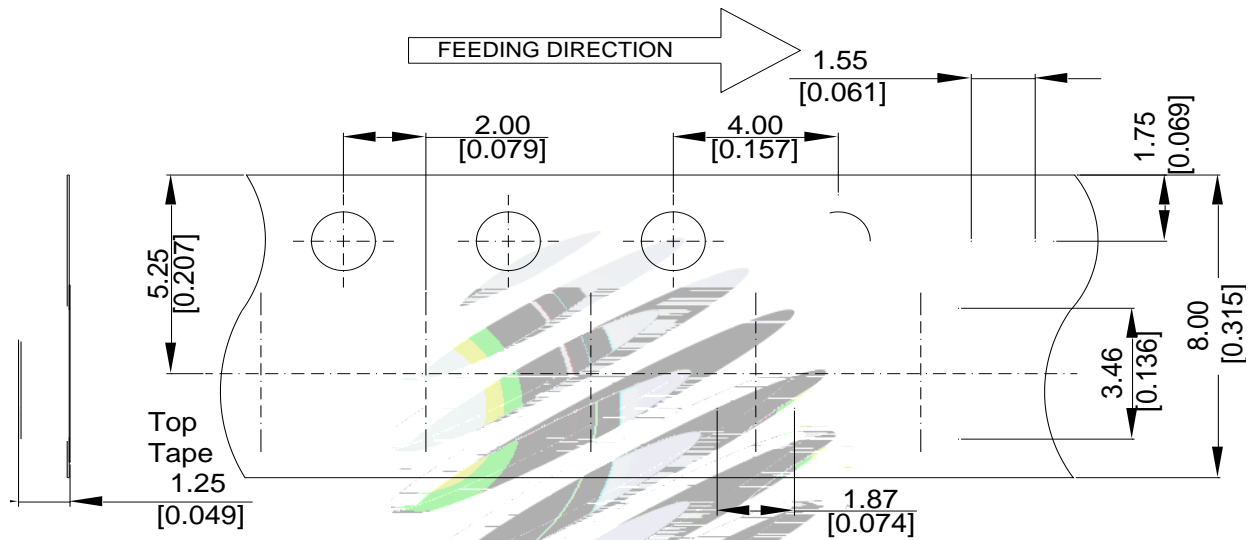

Fig.2-1 Carrier Tape Dimension

#### 2.1.2 Reel Dimension



Table 2-1 Dimension

A	8.0 $\pm$ 0.1mm
B	178 $\pm$ 1mm
C	60 $\pm$ 1mm
D	13.0 $\pm$ 0.5mm

Fig.2-2 Reel Dimension

#### Notes

The tolerances unless mentioned  $\pm 0.1$ mm. Unit : mm



### 2.1.3 Label Form Specification

Table 2-2 Parameter

PART NO.	Part Number
SPEC NO.	Spec Number
LOT NO.	Lot Number
BIN CODE	Bin Code

Fig. 2-3 Label Form Specification

### 2.2 Moisture Resistant Packing

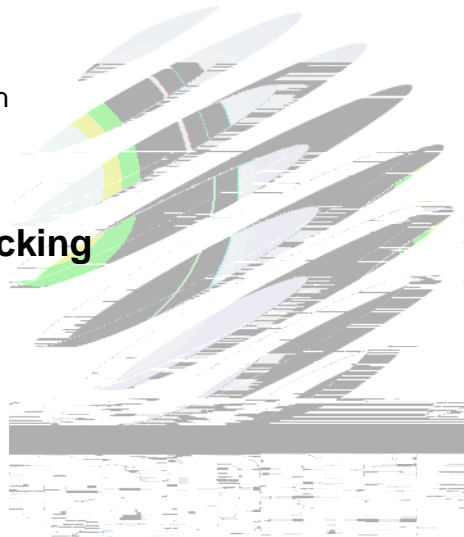

Fig.2-4 Moisture Resistant Packing

## 2.3 Cardboard Box

Fig.2-5 Cardboard Box

## 2.4 Reliability Test Items And Conditions

Table 2-3 Reliability Test Items And Conditions

Test Items	Ref.Standard	Test Condition	Time	Quantity	Ac/Re
Reflow					/



## 2.5 Criteria For Judging Damage

Table 2-4 Criteria For Judging Damage

Test Items	Symbol	Test Condition	Criteria For Judgement	
			Min.	Max.
Forward Voltage	$V_F$	$I_F=20mA$	-	U.S.L*)x1.1
Reverse Current	$I_R$	$V_R= 5V$	-	U.S.L*)x2.0
Luminous Flux		$I_F=20mA$	L.S.L*)x0.7	-

### Notes

1.U.S.L: Upper standard level

L.S.L: Lower standard level

2.The above reliability tests is based on the verification of a single/strip LED of Refond's existing experimental platform,the reliability experiment was taken under good heat dissipation conditions. When customers applies the LED to the series and parallel circuit,should take consideration of all the factors such as the current, voltage distribution, heat dissipation and others.

LED

3.The technical information shown in the data sheets is limited to the typical characteristics and circuit examples of the referenced products. It does not constitute the warranting of industrial property nor the granting of any license.





### 3. SMT Reflow Soldering Instructions SMT

#### 3.1 SMT Reflow Soldering Instructions SMT

Fig.3-1 SMT Reflow Soldering Instructions SMT

Table 3-1 Parameter

Average temperature rise speed	$T_{smax}$ $T_P$	3 °C/ Max 3 °C/ s
Preheating: minimum temperature	( $T_{smin}$ )	150 °C
Preheating: Max temperature	( $T_{smax}$ )	200 °C
Preheating: Time	$T_{smin}$ $T_{smax}$	60 - 120 60s-120s
Time limited to maintain high temperature: the temperature	( $T_L$ )	217 °C

Time limited to maintain high temperature: The Time

Notes

(1)Reflow soldering should not be done more than twice. If more than 24 hours between the two solderings ,  
LED will be damaged. 24 LED

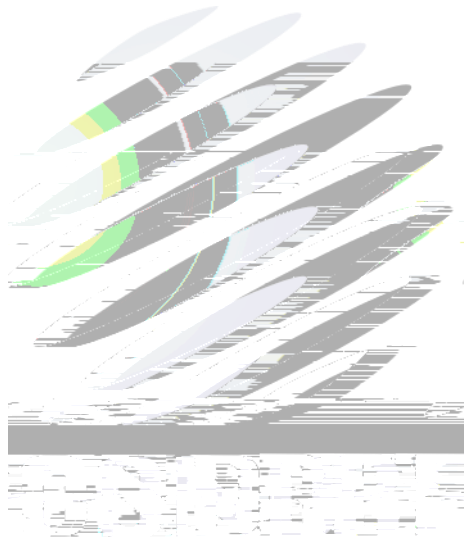

## 4. Handling Precautions

### 4.1 Handling Precautions

(1) LED operating environment and sulfur element composition can not be over 100PPM in the LED mating usage material. This is provided for informational purposes only and is not a warranty or endorsement. LED 100PPM.

(2) In order to prevent external material from getting into the inside of LED, which may cause the malfunction of LED, the single content of Bromine element is required to be less than 900PPM, the single content of Chlorine element is required to be less than 900PPM, the total content of Bromine element and Chlorine element in the external materials of the application products is required to be less than 1500PPM. This is provided for informational purposes only and is not a warranty or endorsement.

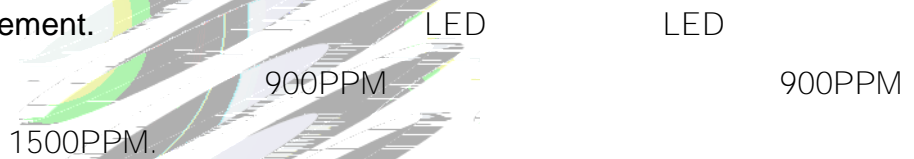

(3) VOCs (Volatile organic compounds) emitted from materials used in the construction of fixtures can penetrate silicone encapsulants of LEDs and discolor when exposed to heat and photonic energy. The result can be a significant loss of light output from the fixture. Knowledge of the properties of the materials selected to be used in the construction of fixtures can help prevent these issues. Refond advises against the use of any chemicals or materials that have been found or are suspected to have an adverse effect on device performance or reliability. To verify compatibility, Refond recommends that all chemicals and materials be tested in the specific application and environment for which they are intended to be used. Attaching LEDs, do not use adhesives that outgas organic vapor. LED

LED

LED

LED



(4) Handle the component along the side surface by using forceps or appropriate tools; Do not directly touch or Handle the silicone lens surface, it may damage the internal circuitry.

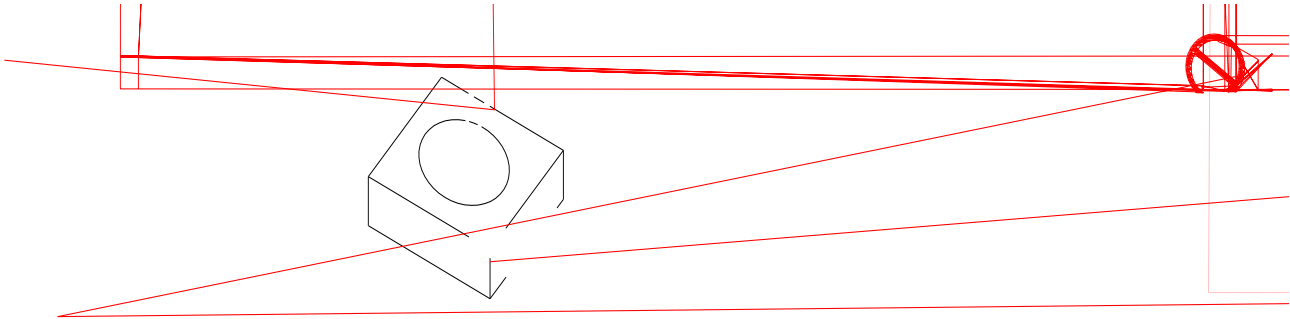

Fig 4-1 Handling Precautions 产品使用注意事项

(5) In designing a circuit, the current through each LED can not exceed the absolute maximum rating specified for each LED. In the mean while, resistors for protection should be applied, otherwise slight voltage shift will cause big current change, burn out may happen. The driving circuit must be designed to allow forward voltage only when it is ON or OFF. If the reverse voltage is applied to LED, migration can be generated resulting in LED damage.

LED



(6) Thermal Design is paramount importance because heat generation may result in the Characteristics decline, such as brightness decreased, Color change and so on. Please consider the heat generation of the LEDs when making the system design. LED

LED

(7) Compared to standard encapsulants, silicone is generally softer, and the surface is more likely to attract dust, requiring special care during processing. In cases where a minimal level of dirt and dust particles cannot be guaranteed, a suitable cleaning solution must be applied to the surface after the soldering of components. Refond suggests using isopropyl alcohol for cleaning. In case other solvents are used, it must be assured that these solvents do not dissolve the package or resin. Ultrasonic cleaning is not recommended. Ultrasonic cleaning may cause damage to the

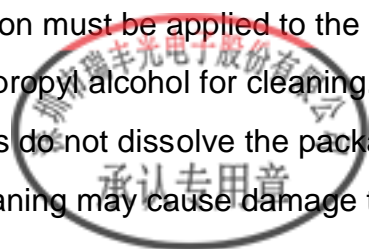

LED.

LED

Table 4-1 Storage

Conditions		Temperature	Humidity	Time
Storage	Before Opening Aluminum Bag	30	75%	Within 1 Year From Date
	After Opening Aluminum Bag	30	60%	168hours 168
Baking		60±5	-	24hours 24

(8) If the moisture absorbent material silica gel has faded away or the LEDs have exceeded the storage time, baking treatment should be performed after unpacking and based on the following condition 60±5 °C for above 24 hours.

60±5 24

If the package is flatulence or damaged, please notify the sales staff to assist.

(9) Similar to most Solid state devices; LEDs are sensitive to Electro-Static Discharge (ESD) and Electrical Over Stress (EOS).

LED

(10) Other points for attention, please refer to our relevant information.







Declare

This specification is written both in English and in Chinese and the latter is formal.