

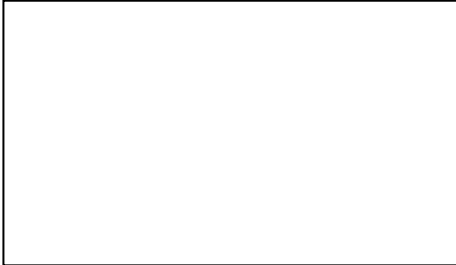

11

11

12

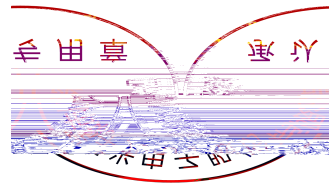

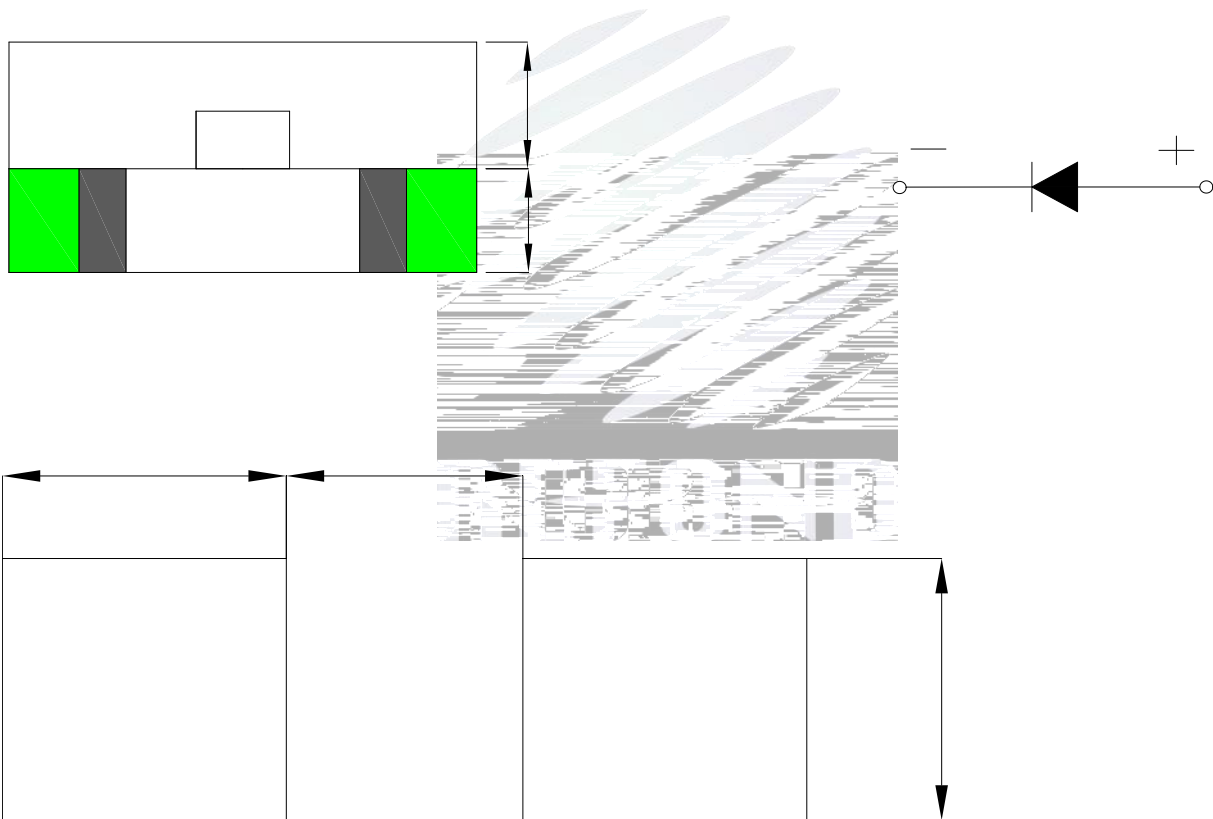
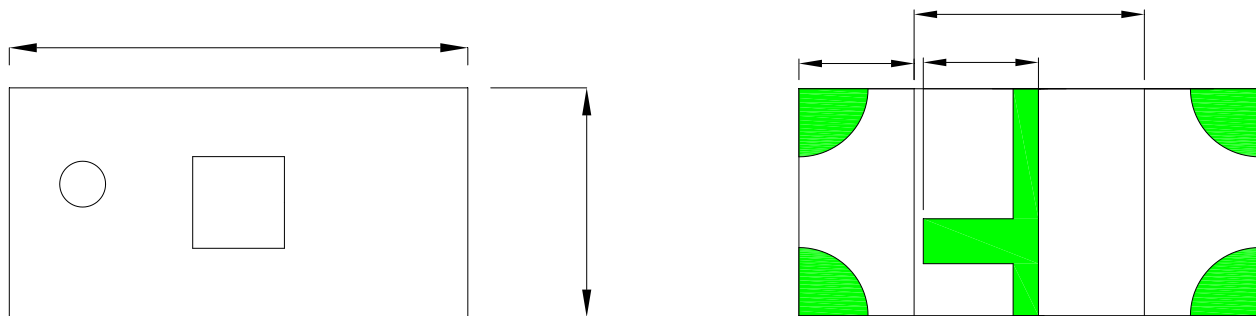

±

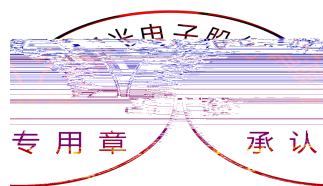



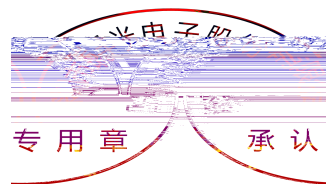

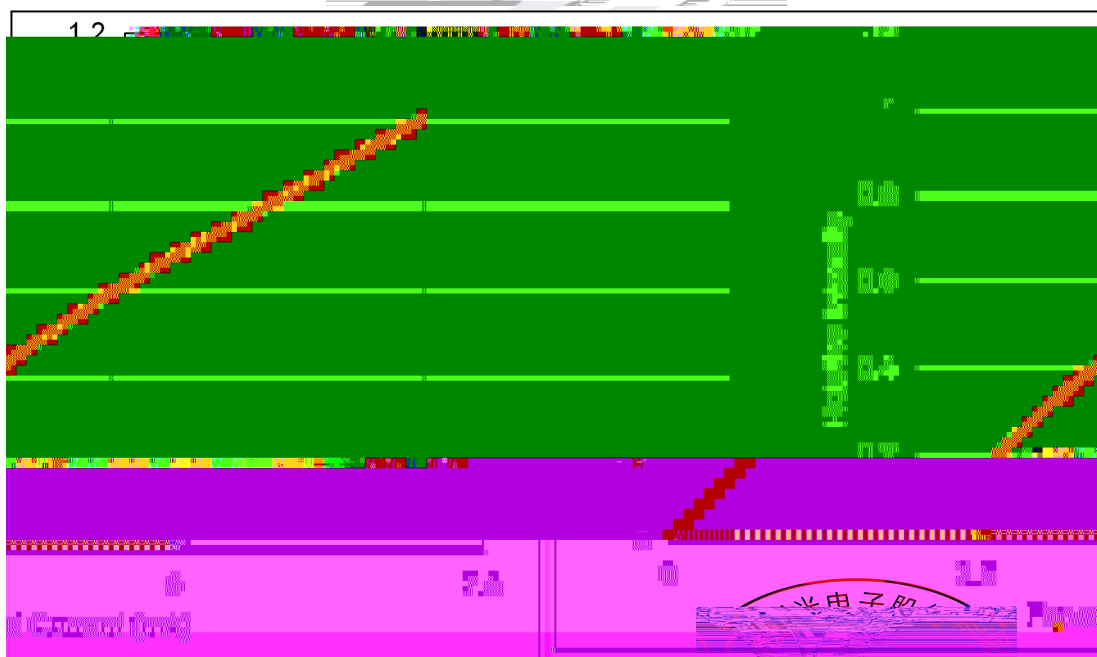
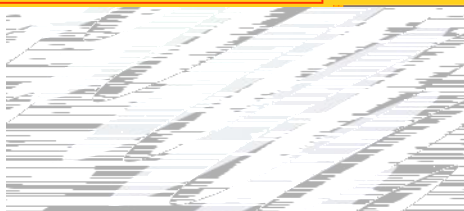
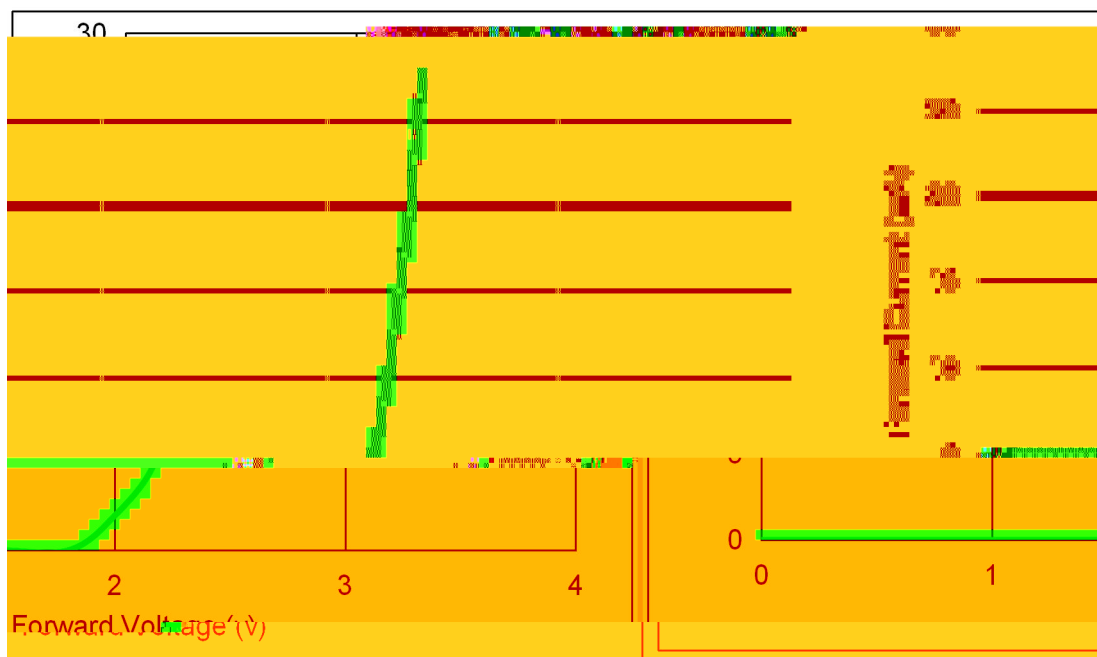

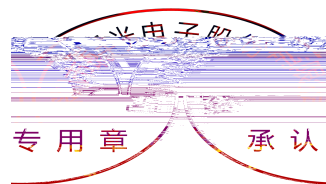

业由子助心  
专用章 承认



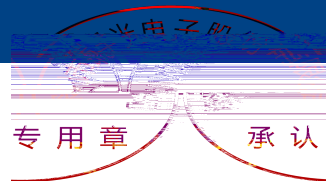
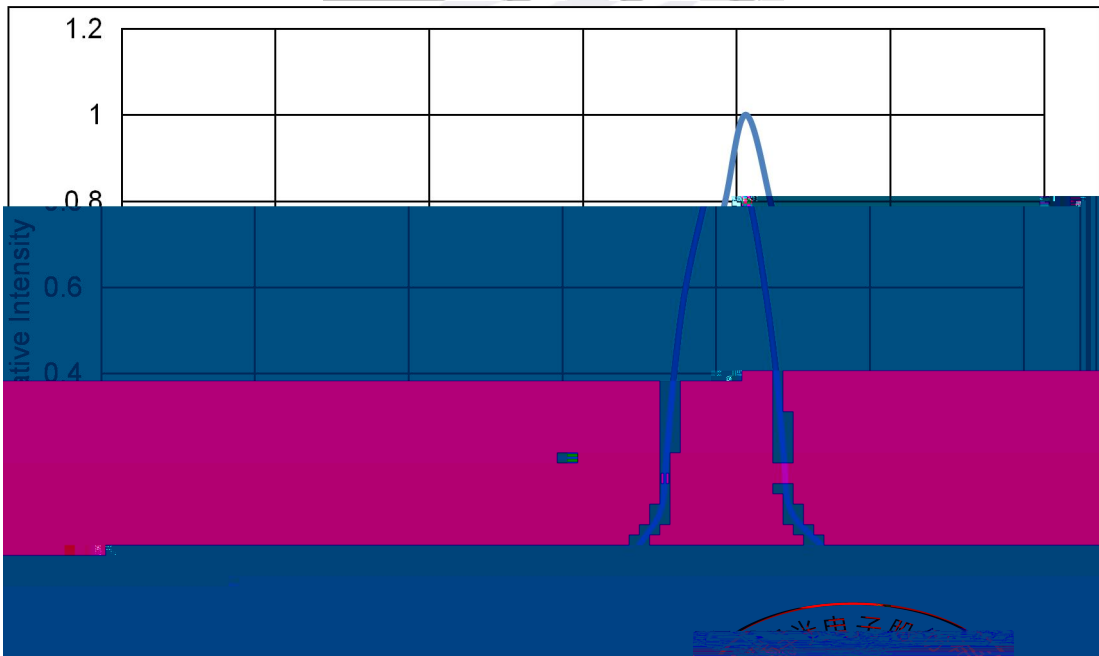
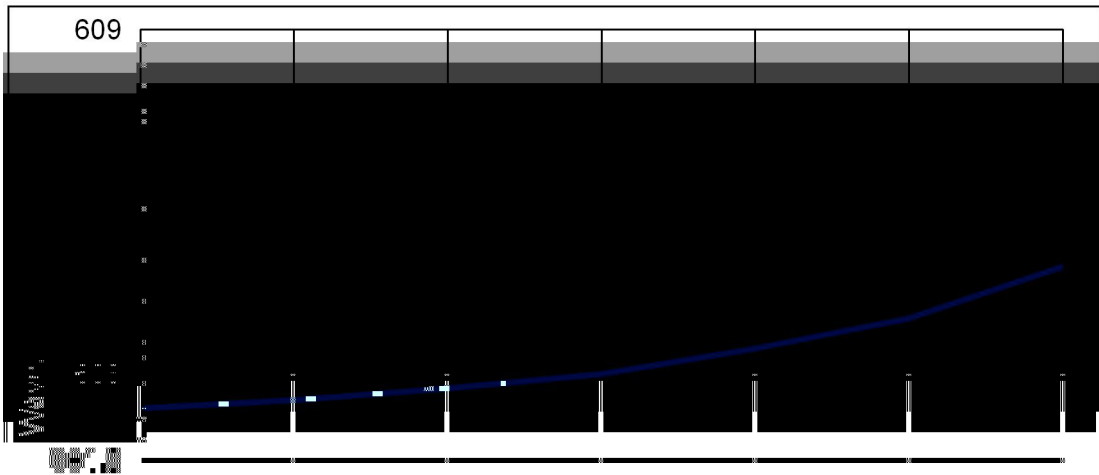



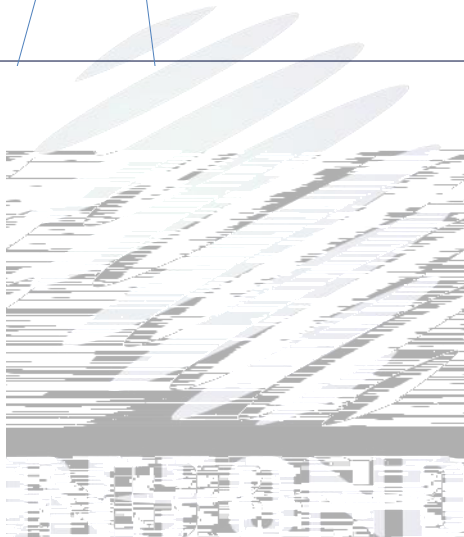
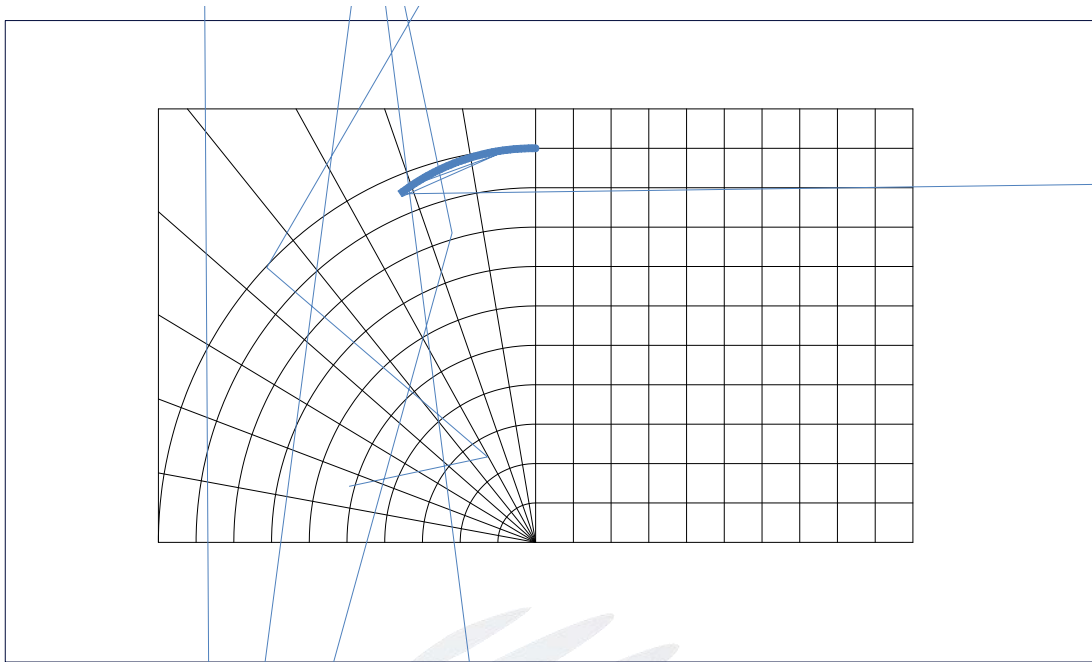

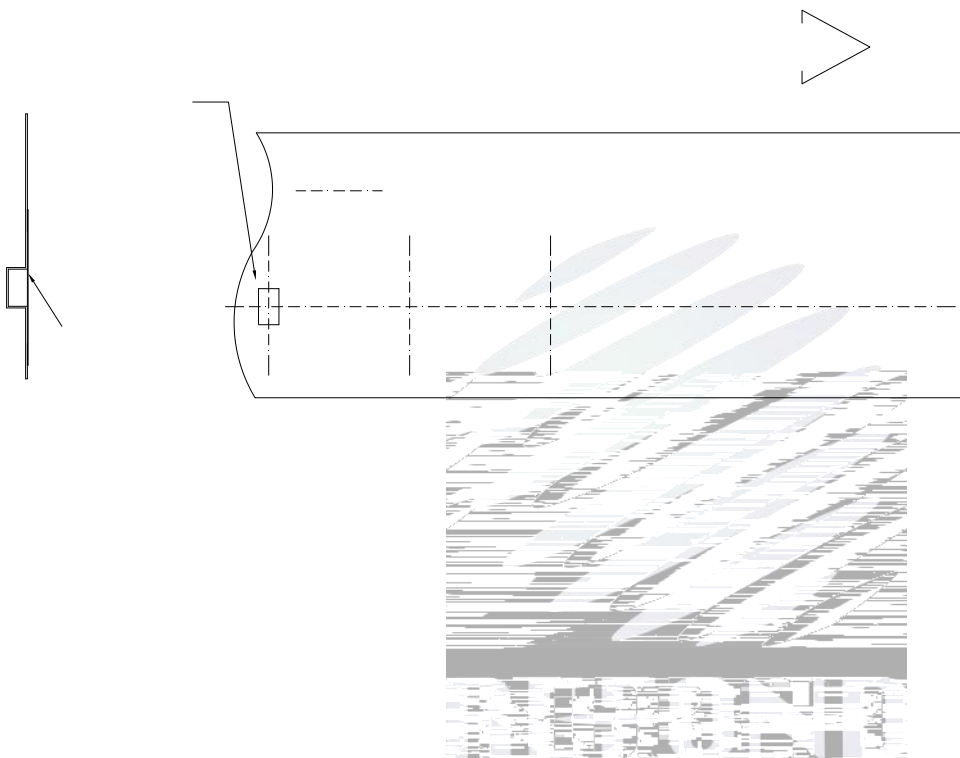



PART NO: \_\_\_\_\_  
 SPEC NO: \_\_\_\_\_  
 LOT NO: \_\_\_\_\_

BIN CODE: \_\_\_\_\_  
 Φ: \_\_\_\_\_ XY: \_\_\_\_\_  
 VF: \_\_\_\_\_ WLD: \_\_\_\_\_

QTY: \_\_\_\_\_  
 DATE: \_\_\_\_\_

---

---

---

---

---

---

---

---

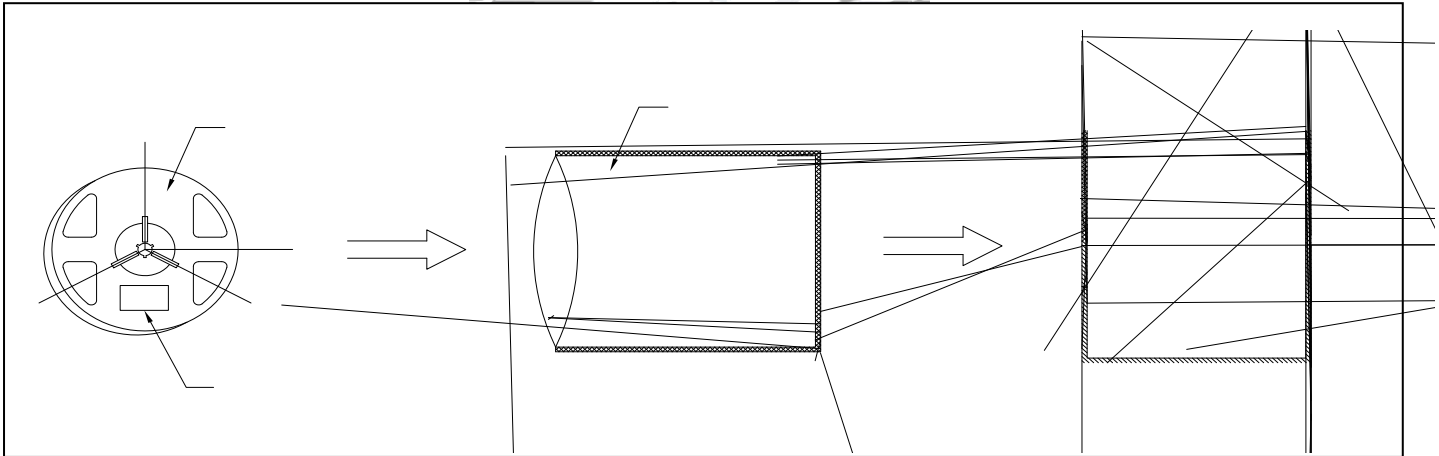

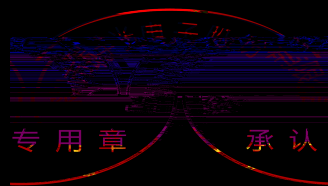

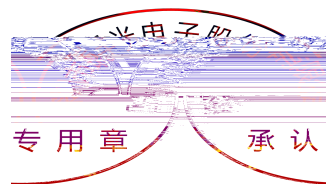



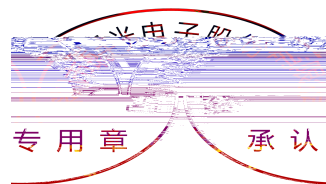



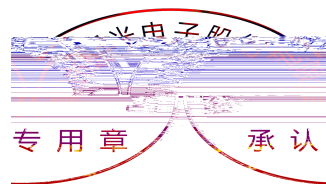



±

