

SPECIFICATION



R&D

Contents

- 1. Description
 - 1.1 General Description
 - 1.2 Features
 - 1.3 Application
 - 1.4 Package Dimension
 - 1.6 Bin Range Of Forward Voltage and Luminous Intensity (IF=140mA) BIN
 - (IF=140mA)
 - 1.7 Typical Optical Characteristics Curves
- 2. Packaging
 - 2.1 Packaging Specification
 - 2.1.1 Carrier Tape Dimension mm mm 12
 - 2.1.2 Reel Dimension 12
 - 2.1.3 Label Form Specification 13
 - 2.2 Moisture Resistant Packing
 - 2.3 Cardboard Box
 - 2.4 Reliability Test Items And Conditions
 - 2.5 Criteria For Judging Damage
- 3. SMT Reflow Soldering Instructions SMT $\times vD^a \phi$
 - 3.1 SMT Reflow Soldering Instructions SMT
- 4. Handling Precautions
 - 4.1 Handling Precautions

1. Description

1.1 General Description

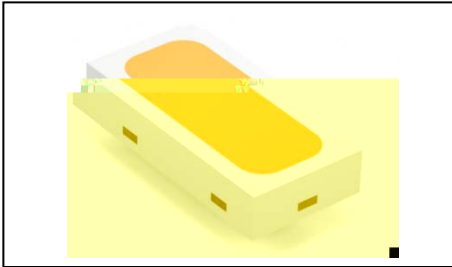

The PC Amber LED, which was fabricated by using a blue chip and the phosphor.

Product Package: 3.00mmX1.40mmX0.52mm.

LED

3.00mmX1.40mmX0.52mm.

1.2 Features

• EMC Package. EMC

• Extremely wide viewing angle.

• Suitable for all SMT assembly and solder process. SMT

• Available on tape and reel.

• Moisture sensitivity level: Level 2. Level2

• RoHS compliant. 2 RoHS0[0]

• Qualifications: The product qualification test plan is based on the guidelines of AEC-Q102 Stress Test Qualification for Automotive Grade Discrete Semiconductors

AEC-Q102

1.3 Application

• Automotive Lighting Interior and Exterior.

1.4 Package Dimension

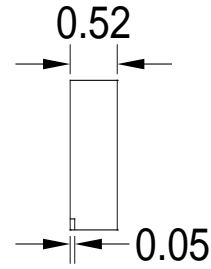
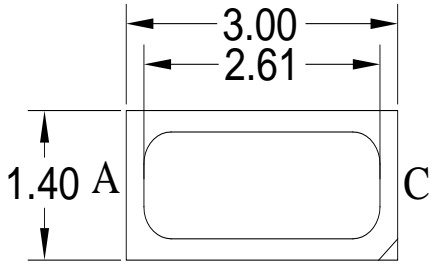

Fig. 1-2 Side View

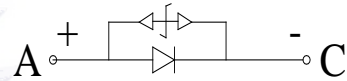
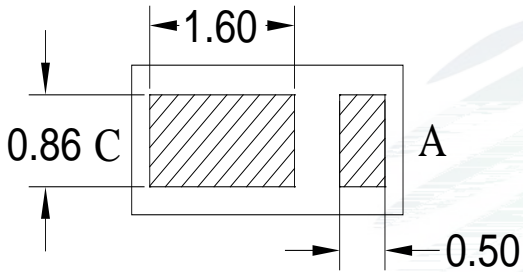

Fig. 1-3 Bottom View

Fig. 1-4 Polarity

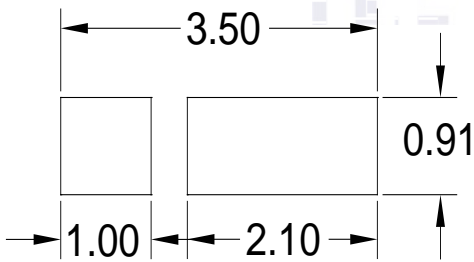

Fig. 1-5 Soldering Patterns

Notes

1. All dimensions units are millimeters.
2. All dimensions tolerances are ± 0.2 mm unless otherwise noted.

± 0.2

1.5 Product Parameters

Table 1-1 Electrical / Optical Characteristics at Ts=25°C

Item	Symbol	Test Condition	Value			Unit
			Min.	Typ.	Max.	
Forward Voltage	V_F	$I_F=140\text{mA}$	2.8	3.0	3.4	V
Reverse Current	I_R	$V_R=5\text{V}$	---	---	10	μA
Luminous Flux	-	$I_F=140\text{mA}$	30	35	45.3	lm
Viewing Angle		$I_F=140\text{mA}$	---	120	---	deg
Thermal Resistance.	R_{THJ-S}	$I_F=140\text{mA}$	---	---	33	$^{\circ}\text{C/W}$

Table 1-2 Absolute Maximum Ratings at Ts=25°C

Parameter	Symbol	Rating	Units
Power Dissipation	P_D	680	mW
Forward Current	I_F	200	mA
Peak Forward Current	I_{FP}	350	mA
Reverse Voltage	V_R	5	V
Electrostatic Discharge (HBM)	E_{SD}	8000	V
Operating Temperature	T_{OPR}	-40 ~ +125	$^{\circ}\text{C}$
Storage Temperature	T_{STG}	-40 ~ +125	$^{\circ}\text{C}$
Junction Temperature	T_J	150	$^{\circ}\text{C}$

Notes

1. 1/10 Duty cycle, 10ms pulse width. 10ms, 1/10.
2. The above forward voltage measurement allowance tolerance is $\pm 0.1V$. $\pm 0.1V$.
3. The above color coordinates measurement allowance tolerance is ± 0.005 . ± 0.005 .
4. The above luminous intensity measurement allowance tolerance $\pm 10\%$.
 $\pm 10\%$.
5. Care is to be taken that power dissipation does not exceed the absolute maximum rating of the product.
6. All measurements were made under the standardized environment of Refond.
7. When the LEDs are in operation the maximum current should be decided after measuring the package temperature, junction temperature should not exceed the maximum rate. LED
8. ESD yield is over 90% at 8000V ESD (HBM). ESD protection during products handling is needed. 90% LED
 ESD8000V

1.6 Bin Range Of Forward Voltage and Luminous Intensity (IF=140mA)

BIN (IF=140mA)

Table 1-3

V _F V	G1	G2	H1	H2	I1	I2
	2.8-2.9	2.9-3.0	3.0-3.1	3.1-3.2	3.2-3.3	3.3-3.4
- (lm)	MA	MB	NA	NB		
	30-33.4	33.4-37	37-40.9	40.9-45.3		

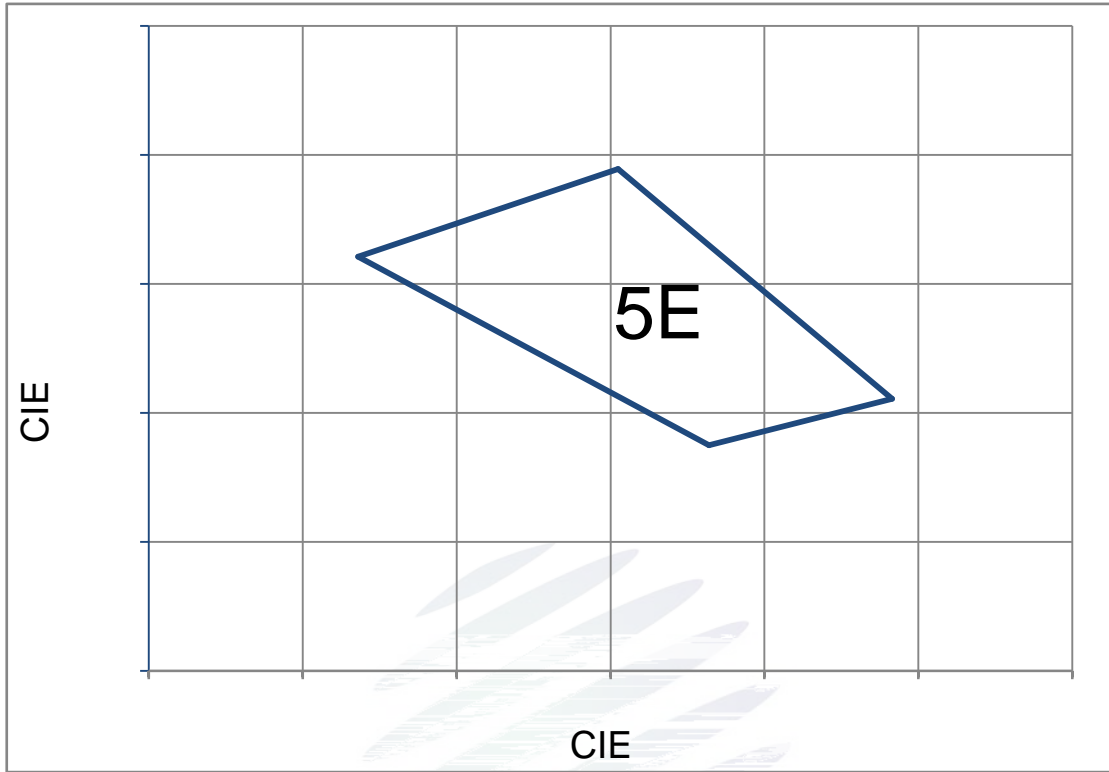

Fig. 1-6 The C.I.E Chromaticity Diagram CIE

Table 1-4

BIN CODE	CIE-X1	CIE-Y1	CIE-X2	CIE-Y2	CIE-X3	CIE-Y3	CIE-X4	CIE-Y4
5E	0.5536	0.4221	0.5764	0.4075	0.5883	0.4111	0.5705	0.4289

1.7 Typical Optical Characteristics Curves

Fig. 1-7 Forward Voltage Vs Forward Current

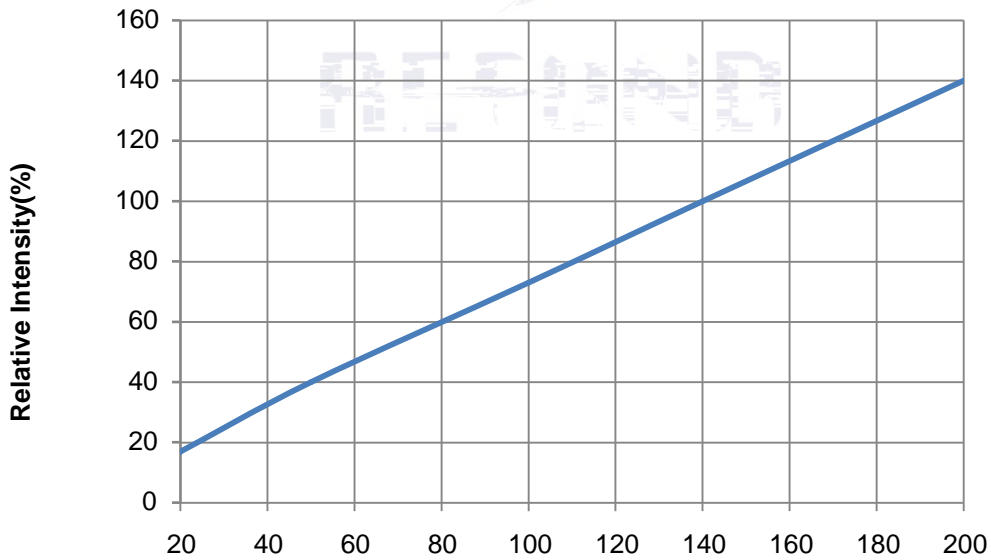

Fig. 1-8 Forward Current Vs Relative Intensity

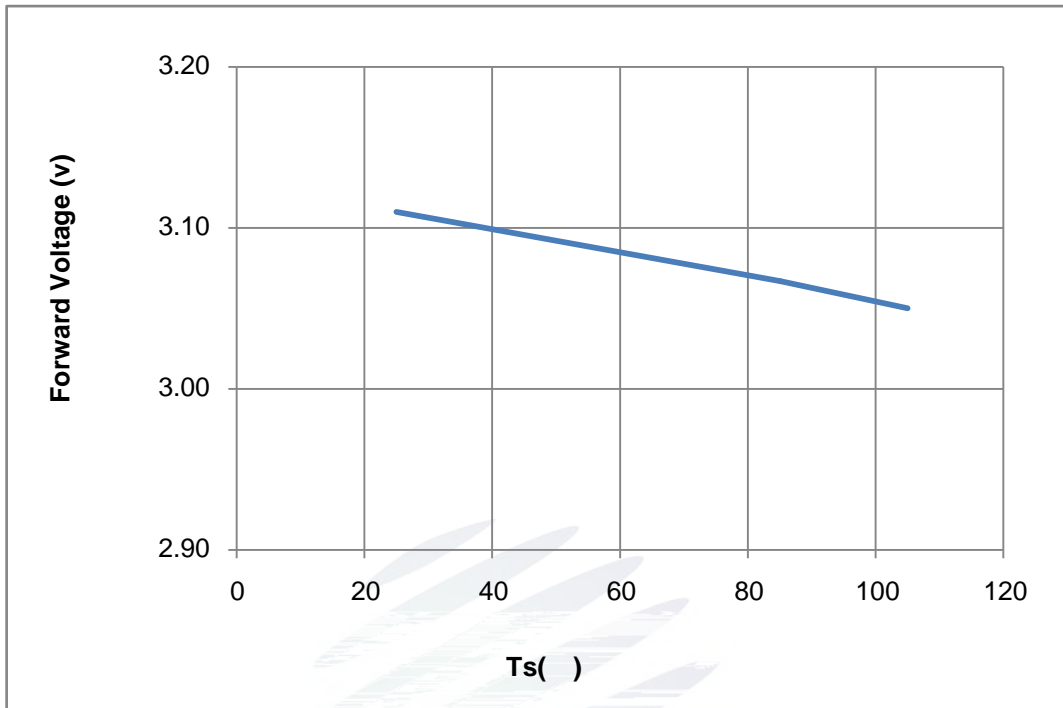

Fig. 1-11 Forward Voltage Vs Solder Temperature

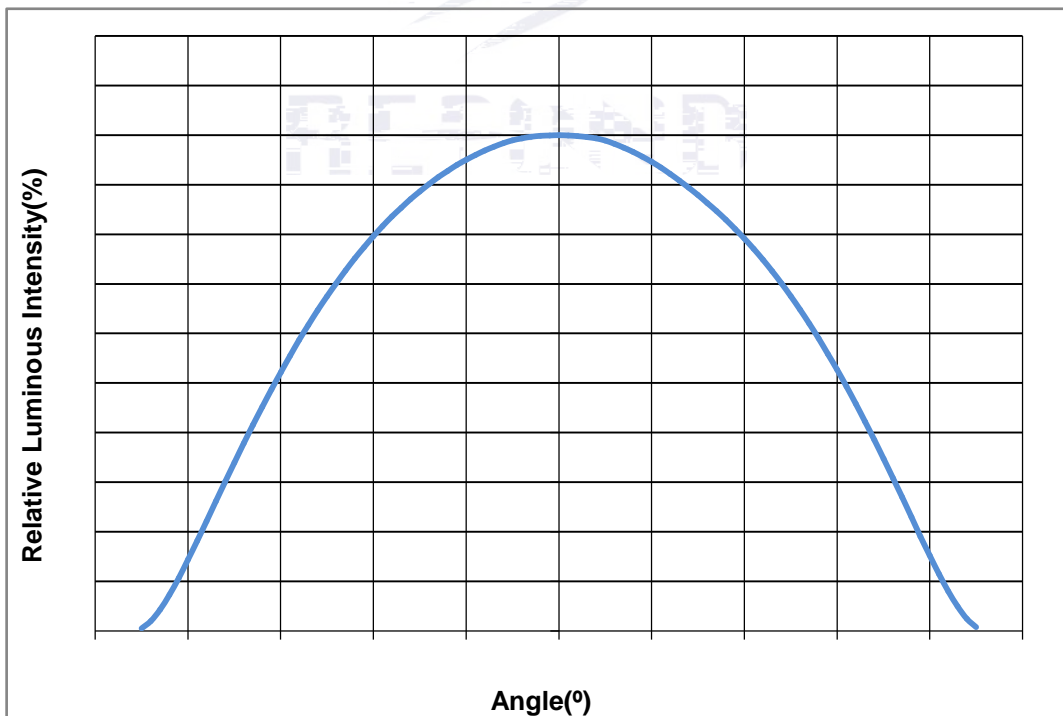

Fig. 1-12 Radiation diagram

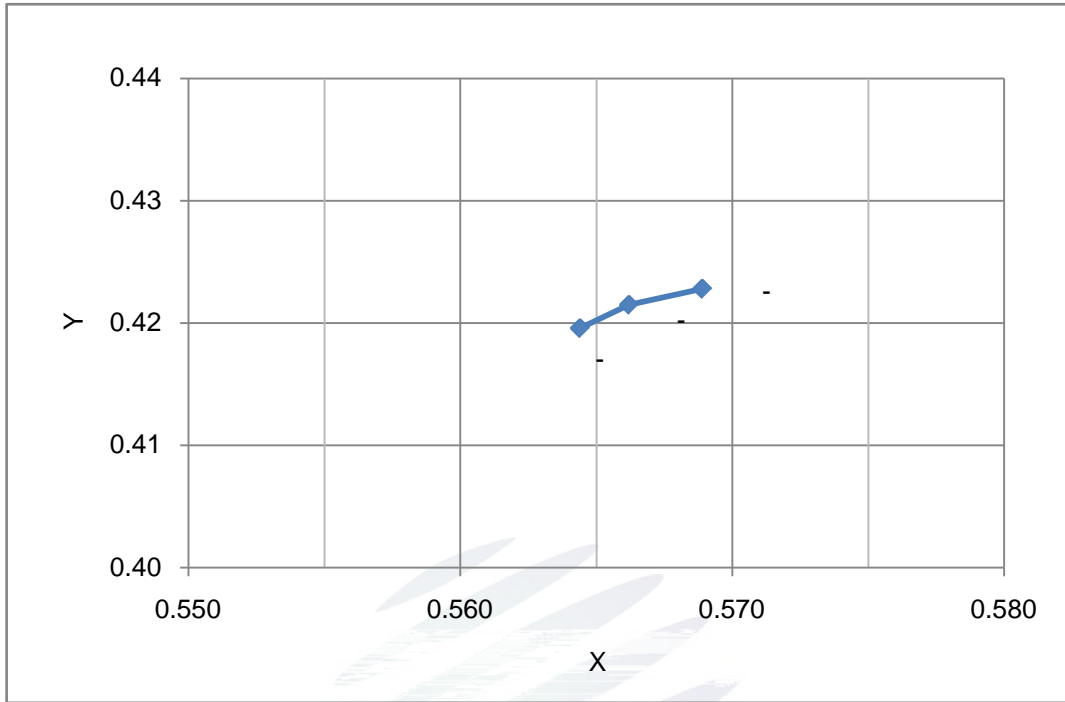

Fig. 1-13 Forward Current vs. Color Shift (Ts=25°C)

(Ts=25°C)

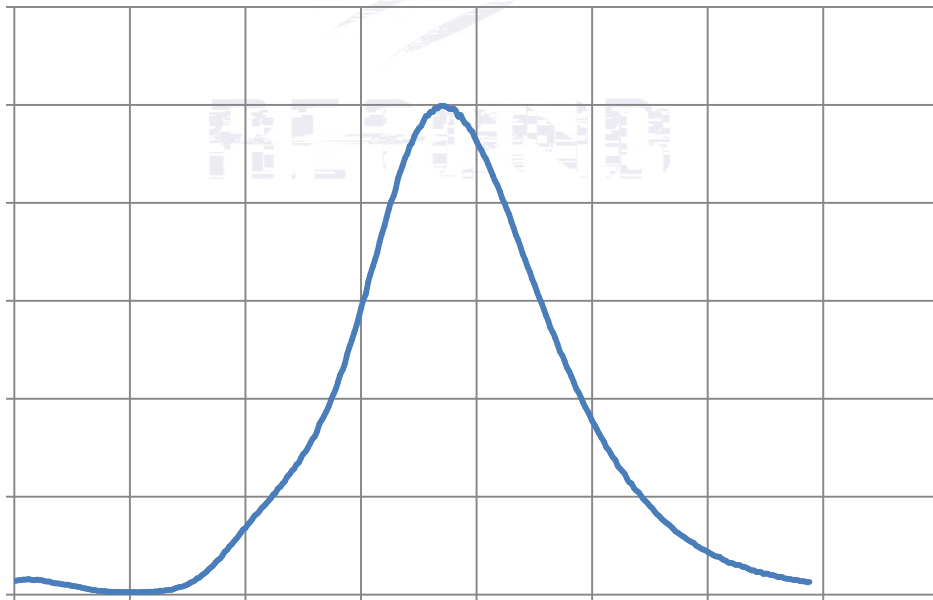

Fig. 1-14 Spectrum Distribution

2. Packaging

2.1 Packaging Specification

Package:5000pcs/reel.

2.1.1 Carrier Tape Dimension mm mm

Fig.2-1 Carrier Tape Dimension

2.1.2 Reel Dimension

Table 2-1 Reel Dimension # F€+â+

Fig.2-2 Reel Dimension # F€+â+

Notes

1

2.1.3 Label Form Specification

Table 2-2 Specification

PART NO.	Part Number
SPEC NO.	Spec Number
LOT NO.	Lot Number
BIN CODE	Bin Code
N	Luminous flux
XY	Chromaticity Bin
V _F	Forward Voltage
WLD	Wavelength
QTY	Packing Quantity
DATE	Made Date

Fig. 2-3 Label Form Specification

2.2 Moisture Resistant Packing

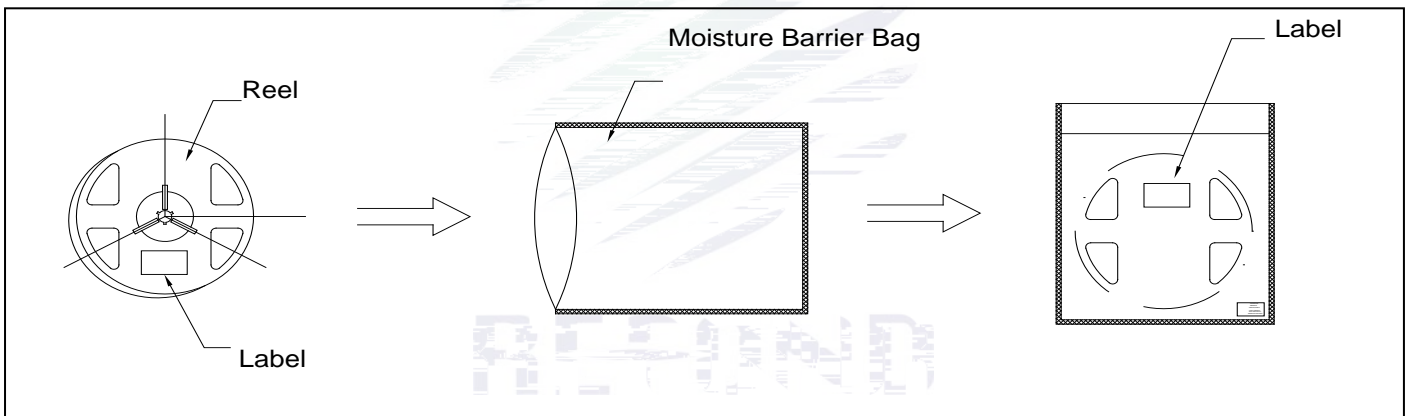

Fig.2-4 Moisture Resistant Packing eU? "-Xm

2.3 Cardboard Box

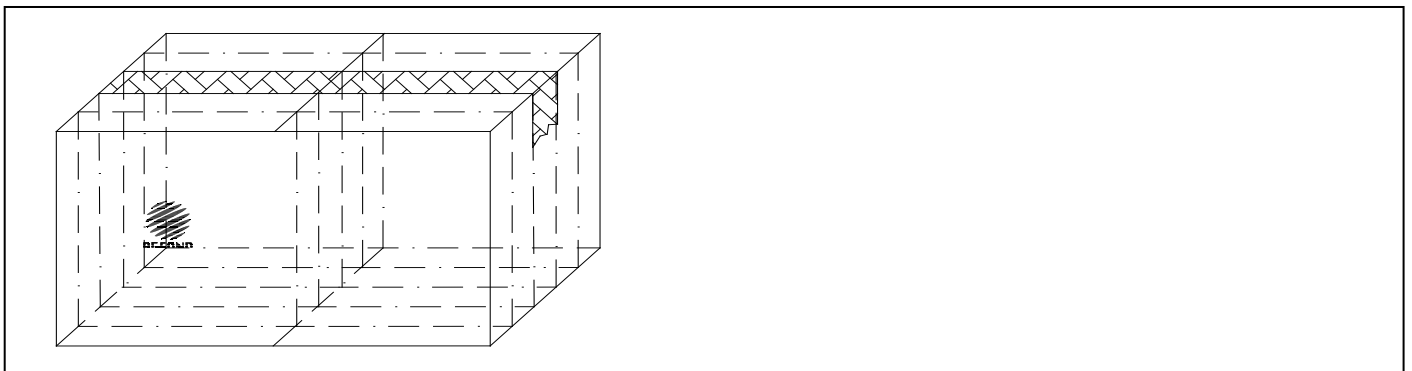

Fig.2-5 Cardboard Box "-XmN`KY

2.4 Reliability Test Items And Conditions

Table 2-3 Reliability Test Items And Conditions

Test Items	Ref.Standard	Test Condition	Time	Quantity	Ac/Re /
Reflow	JESD22-B106	Temp:260 max T=10 sec	2times	20pcs.	0/1
MSL2 2	JESD22-A113	85 / 60%RH	168 hrs.	20pcs.	0/1
Thermal Shock	JEITAED-4701 300307	-40 15min 9 ;10s 125 15min	1000 cycle	20pcs.	0/1
Life Test	JESD22-A108	Ta=105 IF=140mA	1000hrs.	20pcs.	0/1
High Temperature High Humidity Life Test	JESD22-A101	85 / 85%RH IF=140mA	1000hrs.	20pcs.	0/1

2.5 Criteria For Judging Damage

Table 2-4 Criteria For Judging Damage

Test Items	Symbol	Test Condition	Criteria For Judgement	
			Min.	Max.
Forward Voltage	V_F	$I_F=140\text{mA}$	-	U.S.L*)x1.1
Reverse Current	I_R	$V_R = 5\text{V}$	-	U.S.L*)x2.0
Luminous Flux	N	$I_F=140\text{mA}$	L.S.L*)x0.7	-

Notes

- 1.U.S.L: Upper standard level L.S.L: Lower standard level
- 2.The above reliability tests is based on the verification of a single/strip LED of Refond's existing experimental platform,the reliability experiment was taken under good heat dissipation conditions. when customers applies the LED to the series and parallel circuit, should take consideration of all the factors such as the current, voltage distribution, heat dissipation and others. / LED
LED
- 3.The technical information shown in the data sheets is limited to the typical characteristics and circuit examples of the referenced products. It does not constitute the warranting of industrial property nor the granting of any license.

3. SMT Reflow Soldering Instructions SMT 3 WD y f

3.1 SMT Reflow Soldering Instructions SMT

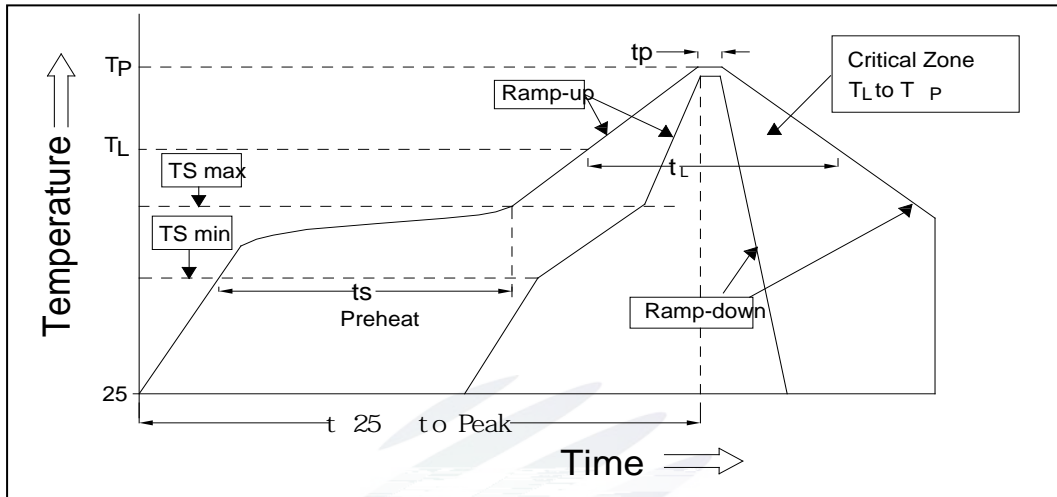

Fig.3-1 SMT Reflow Soldering Instructions SMT

Table 3-1 Reflow parameters

Average temperature rise speed	Tsmax TP	3 °C/ Max 3 °C/ s
Preheating: minimum temperature	(Tsmín)	150 °C
Preheating: Max temperature	(Tsmáx)	200 °C
Preheating: Time	Tsmín Tsmax	60 - 120 60s-120s
Time limited to maintain high temperature: the temperature	(TL)	217 °C
Time limited to maintain high temperature: The Time	(tL)	60 Max 60s
Peak /Classification of temperature:	(TP)	260 °C
Time limit classification of peak temperature time	tp	10 Max 10s
(TP) 5 °C Hold time within 5 °C with the actual peak temperature (TP)		30 Max 30s
Cooling speed		6 °C/ Max 6 °C/ s
25 °C	Needed time from 25 °C to Tp	8 Max 8 minutes

Notes

(1)Reflow soldering should not be done more than twice. If more than 24 hours between the two solderings , LED will be damaged.

(2)When soldering , do not put stress on the LEDs during heating.

3.1.1 Cautions

(1) The encapsulated material of the LEDs is silicone. Therefore the LEDs have a soft surface on the top of package. The pressure to the top surface will be impacted on the reliability of the LEDs. Precautions should be taken to avoid the strong pressure on the encapsulated part. So when use the picking up nozzle, the pressure on the silicone resin should be proper.

(2) Components should not be mounted on warped (non coplanar) portion of PCB. After soldering, do not warp the circuit board.

(3) Do not apply mechanical force or excess vibration during the cooling process to normal temperature after soldering. Do not rapidly cool device after soldering.



4. Handling Precautions

4.1 Handling Precautions

(1) LED operating environment and sulfur element composition cannot be over 100PPM in the LED mating usage material. This is provided for informational purposes only and is not a warranty or endorsement. LED -•

CW(+#r ¶ LED _a`õF,6ø5A ÖH ëLË#r"¼#°B 1, ¥ µ#—]-_o 100PPM._•#’5x ” Ò.ç[Vp» µ £ ý\$ìÐ2m ... ä

(2) In order to prevent ex-ternal material fro



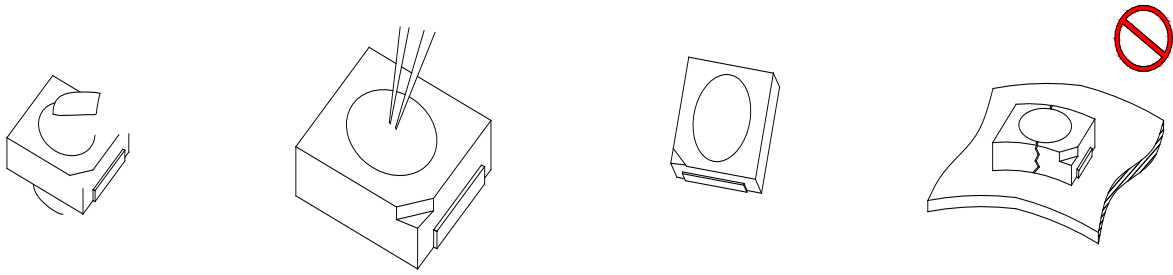

Fig 4-1 Handling Precautions

(5) In designing a circuit, the current through each LED can not exceed the absolute maximum rating specified for each LED. In the mean while, resistors for protection should be applied, otherwise slight voltage shift will cause big current change, burn out may happen. The driving circuit must be designed to allow forward voltage only when it is ON or OFF. If the reverse voltage is applied to LED, migration can be generated resulting in LED damage.

(6) Thermal Design is paramount importance because heat generation may result in the Characteristics decline, such as brightness decreased, Color change and so on. Please consider the heat generation of the LEDs when making the system design.

(7) Compared to standard encapsulants, silicone is generally softer, and the surface is more likely to attract dust, requiring special care during processing. In cases where a minimal level of dirt and dust particles cannot be guaranteed, a suitable cleaning solution must be applied to the surface after the soldering of components. Refond suggests using isopropyl alcohol for cleaning. In case other solvents are used, it must be assured that these solvents do not dissolve the package or resin. Ultrasonic cleaning is not recommended. Ultrasonic cleaning may cause damage to the LED.

Table 4-1 Storage

Conditions		Temperature	Humidity	Time
Storage	Before Opening Aluminum Bag	30	75%	Within 1 Year From Date
	After Opening Aluminum Bag	30	60%	Recommended for use within 24 hours 1% ^o = .ž8...\$ " G.
Baking		60± 5	-	24hours 24

(8) If the moisture absorbent material (silica gel) has faded away or the LEDs have exceeded the storage time, baking treatment should be performed after unpacking and based on the following condition (60±5p, B] for above 24 hours.)

If the package is flatulence or damaged, please notify the sales staff to assist.

(9) Similar to most Solid state devices; LEDs are sensitive to Electro-Static Discharge (ESD) and Electrical Over Stress (EOS).

(10) Other points for attention, please refer to our relevant information.



Declare

This specification is written both in English and in Chinese and the latter is formal.